

Section 1 - Project Information

Project: **Flint Public Library
Furniture Bid Package**
1026 E. Kearsley Street
Flint, MI 48503

Designer/Specifier: OPN Architects, Inc.
Contact: Erica Steapp
200 Fifth Avenue SE, Suite 201
Cedar Rapids, Iowa 52401
Phone: 319.363.6018
Email: esteapp@opnarchitects.com

Owner/User: Flint Public Library
Contact: Kay Schwartz, Director of Library Services
1026 E. Kearsley Street
Flint, MI 48503
Phone: 810-249-2038
Email: kschwartz@fpl.info

Contact: Connie Palmer, Director of Finance, HR & Facilities
1026 E. Kearsley Street
Flint, MI 48503
Phone: 810-249-2043
Email: cpalmer@fpl.info

Construction Manager: Clark Construction
Attention: Chad Cooley
3535 Moores River Drive
Lansing, MI 48911
C 517.819.4980
Email: ccooley@clarkcc.com

End of Project Information Section

Section 2 – Instructions to Bidders

- A. Bids shall be provided on the Proposal Bid Form(s) attached, shall be identified with the project RFQ # in the subject line, signed by a principal of vendor, and shall be sent physically and electronically to:

OPN Architects
Erica Steapp
200 5th Ave SE Suite 201
Cedar Rapids, Iowa 52401
email: esteapp@opnarchitects.com

Bids must be received (physically and electronically) by 10:00 AM EST on Tuesday May 25, 2021

- B. Bidders shall carefully read the General Conditions and Supplemental Conditions. In submitting bids, bidders agree to the General Conditions and Supplemental Conditions without exception and agree that these Conditions form a part thereof.
- C. Flint Public Library will award contracts on the basis of low and/or qualified bid for each section, but this does not exclude several sections being awarded to one bidder. Bidders should complete the section on which they are bidding in its entirety, including total price, freight, delivery and installation. Flint Public Library will make the award deemed to be in its best interest. All items, within vendor package, must be bid in order for the bid to be considered.
- D. Bidders shall NOT contact the Flint Public Library. All questions to be submitted via email to OPN Architects, Erica Steapp at esteapp@opnarchitects.com. All questions submitted will be answered via Addendum #1 - within 5 days (May 7, 2021) after bids are issued and via Addendum #2 within 10 days (May 14, 2021) after bids are issued. Questions submitted by other means will not be addressed.
- E. Bidders shall submit bids on items specified or submit a proposed equal using the alternate form included. Comparable products considered are subject to compliance with all items indicated following the specifications (i.e. general requirements, implied performance by products specified, quality, etc). No substitutions will be considered after the bid is received. Whenever a material, article, or piece of equipment is identified in the Specification Documents by reference to manufacturers or vendors' names, trade names, catalogue numbers, etc., it is intended merely to establish a standard. Any material, article, or equipment of other manufacturers and vendors that will perform adequately the duties imposed by the design intent will be considered equally acceptable provided the material, article, warranty, or equipment proposed is, in the opinion of the Designer/Specifier, of equal substance and function. Bidders shall submit a completed Alternate Form for each Alternate to be considered. However, such substitution material, article, or equipment shall not be purchased or installed by the Vendor without the Designer/Owners Representative written approval through completion of the Product Evaluation Criteria Form.
1. All comparable products shall include documentation showing it is equivalent.
 2. The award of the contract may be made by Flint Public Library to any responsible bidder or bidders offering suitable supplies at the lowest price taking into consideration the quality of materials or service, in the best interest of the Owner. The right is reserved to reject any and all bids or any part thereof, and to waive informalities or irregularities therein, and to award contracts to other than the Bidder (s) submitting the best financial -

Section 2 – Instructions to Bidders Continued

- bid (low bidder), in its sole and absolute discretion and as deemed in the best interest of the Flint Public Library.

- F. Final Bids shall be reviewed by Flint Public Library and OPN Architects at a virtual public bid opening at 11:00 am EST on Tuesday May 25, 2021. Final Bids and Vendor selections will be posted at a later date on the Flint Public Library website, www.fpl.info.
- G. Lump sum totals for each section of the Bid shall be indicated in accordance with the Proposal for Furniture letter format included in Section 5. Bidders must also include an itemized price list showing each product with unit prices, discounts, and extensions as indicated on the Furniture Bid Form. All prices must be Freight on Board (F.O.B.) to the identified job delivery site.
- H. In the event of delay of delivery of furniture, and if storage is required, the Owner will pay 50% of invoice value of furniture, not including installation costs, when proof of arrival, Vendor's inspection, storage, and certificates of storage have been delivered to Owner.
- I. The Owner reserves the right to accept or reject any or all quotes, to waive irregularities or technicalities in any quote, and to accept any quote which the Owner deems to be in its best interest.
- J. Upon award of the contract, the selected Vendor shall provide insurance certificate to the Owner of complete and current liability insurance to cover all materials and equipment, Vendor's employees while on the job site, and damages to Owner's properties during delivery, installation, and clean-up. The Insurance coverage shall be subject to approval of the Owner, as to adequacy of protection.
- K. Contractor shall purchase and maintain, at its own expense, for the duration of the contract, insurance against claims for injuries to persons or damages to property which may arise from or in connection with the work by the Contractor, its agents, representatives, or employees.

Coverage Required	Limits per occurrence
General liability	\$1 million minimum coverage per occurrence and \$2 million aggregate, written on an occurrence basis
Automobile liability	\$1 million per occurrence, covering owned, hired, and non-owned automobiles
Worker's compensation	Statutory

- L. The Owner reserves the right to order additional specified items for this project at the originally quoted prices for a period of (120) days after the final furniture installation date.

IRAN ECONOMIC SANCTIONS ACT

Each Bid must be accompanied by a sworn and notarized statement certifying that the Contractor is not an "Iran linked business" within the meaning of the Iran Economic Sanctions Act as required in MCL PA 517 of 2012.

FAMILIAR DISCLOSURE DOCUMENTS

Bid shall be accompanied by a sworn and notarized statement disclosing any familial relationship that exists between the owner or any employee of the Bidder and any member of the Flint Library Board of Trustees. The Flint Library will not consider a Bid that does not include this sworn and notarized statement.

Flint Public Library
Flint, Michigan

Furniture Bid Package
OPN Project #: 17215000

CRIMINAL BACKGROUND CHECKS

Each Bid must be accompanied by a sworn and notarized Affidavit of Compliance Criminal Background Checks. Flint Public Library requires all Contractor owners, employees, agents, representatives, subcontractors, and/or other personnel who will be present on Library grounds to submit to a criminal history background check upon request. This background check will include a requirement for each contractor owner, employee, agent, representative, subcontractor, and/or other personnel to be screened before he/she enters Library grounds. A valid State ID card or Driver's License is required to complete the background check.

FAIR LABOR STANDARDS

All successful bidders must comply with the federal labor standards, including the Davis Bacon Act and federal equal opportunity requirements.

FORCE MAJEURE

If the Library is unable to perform its obligations or to accept the services or goods because of Force Majeure (as herein after defined), the time for such performance by the Library or acceptance of services will be equitably adjusted by allowing additional time for performance or acceptance of services equal to any periods of Force Majeure. "Force Majeure" shall mean any delays caused by acts of God, riot, war, terrorism, inclement weather, labor strikes, material shortages and other causes beyond the reasonable control of the Library.

AFFIDAVIT OF COMPLIANCE – IRAN ECONOMIC SANCTIONS ACT
Michigan Public Act No. 517 of 2012

The undersigned, the owner or authorized officer of the below named Bidder (the "Bidder"), pursuant to the compliance certification requirement provided in the Flint Library (the "Library") Request For Bids For (the "RFB"), hereby certifies, represents and warrants that the Bidder (including its officers, directors and employees) is not an "Iran linked business" within the meaning of the Iran Economic Sanctions Act, Michigan Public Act No. 517 of 2012 (the "Act"), and that in the event Bidder is awarded a Contract as a result of the aforementioned RFB, the Bidder/Contractor will not become an "Iran linked business" at any time during the course of performing the Work or any services under the Contract.

The Bidder further acknowledges that any person who is found to have submitted a false certification is responsible for a civil penalty of not more than \$250,000.00 or 2 times the amount of the contract or proposed contract for which the false certification was made, whichever is greater, the cost of the School District's investigation, and reasonable attorney fees, in addition to the fine. Moreover, any person who submitted a false certification shall be ineligible to bid on a request for proposal for three (3) years from the date it is determined that the person has submitted the false certification.

BIDDER:

Name of Bidder

By:

Its:

Date:

STATE OF _____).

COUNTY OF _____)

This instrument was acknowledged before me on the _____ day of _____, 20__,

by _____.

_____, Notary Public

_____ County, _____

My Commission Expires: _____

Acting in the County of : _____

FAMILIAL DISCLOSURE AFFIDAVIT

The undersigned, the owner or authorized officer of _____ (the "Bidder"), pursuant to the familial disclosure requirement provided in the Flint Library (the "Library") Request For Bids hereby represents and warrants that, except as provided below, no familial relationships exist between the owner or any employee of the Bidder, and any member of the Board of Trustees or its Director of Library Services. A list of the Board of and its Director of Library Services may be found at <http://www.fpl.info>.

List any Familial Relationships:

BIDDER:

By:
Its:

STATE OF _____
COUNTY OF _____

This instrument was acknowledged before me on the _____ day of _____, 2021, by
_____.

Notary Public

County, _____
My Commission expires: _____
Acting in the County of : _____

AFFIDAVIT OF COMPLIANCE – CRIMINAL BACKGROUND CHECKS

The undersigned, the owner or authorized officer of the below-named contractor (the "Contractor"), pursuant to the criminal background compliance certification requirements of Flint Library (the "Library") hereby represents and warrants that the Contractor has performed and/or will perform sufficient criminal background checks, including at a minimum, an Internet Criminal History Tool ("ICHAT") check, for all of its owners, employees, agents, representatives, contractors and/or other personnel who will be on Library premises to carry out the services contemplated by the Contract Documents. The Contractor further hereby certifies that no owner, employee, agent, representative, contractor and/or other personnel of the Contractor will be on Library premises if they are a registered criminal sexual offender under the Sex Offenders Registration Act, Public Act 295 of 1994, or have been convicted of "Listed Offense" as defined under Section 722 of the Sex Offenders Registration Act, MCL 28.722.

The Contractor further acknowledges that if it is found to have submitted a false certification or otherwise fails to comply with the requirements of this certification, the School District may immediately terminate the Contract.

CONTRACTOR:

Name of Contractor

By:

Its:

Date:

STATE OF _____.

COUNTY OF _____)

This instrument was acknowledged before me on the _____ day of _____, 202__, by

Notary Public

County, _____

My Commission expires: _____

Acting in the County of : _____

End of Instructions to Bidders Section 2

Section 3 - General Conditions

3.01 Scope of Work

- A. This general description for the proposed project shall provide an overview of the project scope. The work includes provision of new furniture in accordance with the Furniture Contract Documents, for Flint Public Library.
- B. The work of the selected furniture Vendor shall include that which is indicated in the Furniture Contract Documents consisting of Bid Package Specifications and Installation Plan Drawings dated Friday April 9, 2021.

<u>Furniture Plan Drawing List</u>	<u>Estimated Furniture Installation Dates</u>
ID110 Furniture Floor Plan	October 25, 2021
ID111 Furniture Floor Plan	October 18, 2021
ID112 Furniture Floor Plan	October 11, 2021

3.02 General Description:

- A. The project consists of providing Furniture Bid Package for the Flint Public Library.

The term "Bidder" shall apply to bidding furniture vendor(s) prior to award of bid.

The term "Vendor" shall apply to the selected furniture Bidder(s) after the award of bid.
- B. The Bidder is responsible for pricing the entire scope of furniture / furnishings for the scope of work for their furniture product indicated on the Furniture Plan Drawings and in the Furniture Specification.
- C. The Furniture Bid Forms are provided for the Bidder to complete. The Furniture Bid Form shall be executed by an officer of the company authorized to execute contracts and the Bidder's legal name must be fully typed and written.
- D. The Bidder, in accordance with the Furniture Contract Documents, including the Drawings and Specifications, shall be responsible for the furnishing of all materials, labor, supplies, tools, transportation, temporary storage supervision, insurance and other facilities necessary for the full performance and completion of the requirements of said documents.

The parties hereto are independent contractors. Nothing in this agreement shall be construed to create a partnership or joint venture between the parties, and neither party shall be considered the agent or employee of the other for any purpose.
- E. The pricing for all specified items shall include the costs of compliance with all national and local codes as applicable to this project.

Section 3 - General Conditions Continued

3.03 Bid Submittal Criteria:

- A. The Bidder's written proposal shall include the following Cost and Supplemental information:
1. The Bidder shall include the following information per specified item on The Furniture Bid Form: Quantity, Unit List Cost, Unit Net Cost, Percent Discount, Extended Cost, Total Cost and Delivery / Installation Cost.
 2. Bidders shall submit Lead Time for all product required, and identification of products that have lead-time issues or that do not comply with the delivery schedule requirements in the project.
 3. Bidders shall submit a list of Project Personnel responsible for the supervision and coordination of order entry, receiving, delivery, installation, and servicing of the project.
 4. Bidders shall submit bids on items exactly as specified. Acceptable Alternates may be considered – refer to individual product specifications for additional instructions. Bidders shall complete the Alternate Form and submit for evaluation. Flint Public Library reserves solely the right to determine the acceptability of any alternate being offered for consideration by the Bidder.
 5. Bidders shall be prepared to, upon request of the Owner, submit copies of Manufacturer's Product Literature.
 6. Bidders shall be prepared to, upon request of the Owner, submit copies of Manufacturer's Product Warranty.
 7. Bidders shall be prepared to, upon request of the owner, submit copies of the manufactures acceptance of COM's as specified in addition to proof of testing of COM's as specified and availability once contract is awarded. COM MUST be reserved.
- B. All submitted pricing should include and list separately packing, freight, delivery, installation costs required deposit/percentage down, and all fees. The Bidder shall list all services included in the final cost.
- C. The Bidder may only price an item in one of the categories indicated on the bid form; specified. If the Bidder cannot provide the specified item, the Bidder shall write in (No Bid).
- D. The selected Vendor's pricing shall be valid without commitment by Owner for one hundred twenty (120) days from the bid date.
- E. The selected Vendor's pricing shall remain in effect for one hundred twenty (120) days from date of final installation.
- F. The Bidder shall furnish a percentage discount structure per manufacturer to be applicable for all additional furniture ordered within one year from the date of final installation.
- G. Delivery and installation shall be during normal working hours of 8:00 am to 5:00 pm, Monday through Friday. In the event that delivery and installation needs to be performed during evenings

Section 3 - General Conditions Continued

or Saturdays, it is understood that this work shall be performed at no additional cost to the Owner. All work shall be performed in accordance with the requirements of local labor agreements.

- H. Bidder shall submit detail specifications and line drawings representing shelving solutions as specified with submittal of bids/forms.

3.04 Bidder Responsibilities:

- A. Each Bidder shall carefully study the Furniture Contract Documents before submitting its bid. The Bidder shall be responsible for all quantities. Any discrepancies between plans and specification must be brought to the attention of OPN.
- B. By submitting a bid, the Bidder represents that it has satisfied itself as to the conditions under which it will be obliged to operate, including any obstructions or restrictions. The selected Bidder shall schedule site visits, as required, to field verify all site conditions and dimensions before ordering the product. The selected Bidder shall be responsible for verification, and coordination, of all field dimensions to ensure fit for all products as specified; and shall report any discrepancies to the Designer / Owner prior to proceeding with product order and installation.
- C. By submitting a bid, the Bidder represents that all work covered by the specifications and drawings, including installation, shall, until completion, be under direct supervision of a project coordinator regularly employed by the Bidder and who shall have adequate experience in all phases of the work covered by these specifications and drawings.
- D. By submitting a bid, the Bidder warrants to the Owner that all materials and furniture supplied under this contract will be new, free from faults and defects, and in conformance with the specifications. All items shall be inspected for damage by the Bidder prior to installation.
- E. The Bidder shall guarantee in writing to the Owner the furniture supplied for a minimum of one (1) year after completion of delivery, installation and acceptance by the Owner. The guarantee shall cover both product (manufacturer's warranty) and installation (Installer/Dealer warranty). If longer guarantees are available, this shall be stated in the Bidder's proposal.
- F. Bidder shall submit detail specifications and line drawings representing shelving solutions as specified with submittal of bid forms.

3.05 Selected Vendor's Responsibilities:

- A. The Selected Vendor (Bidder awarded with the project) shall be responsible for final quantities, dimensions, adequate connections and details of all specified items for satisfactory completion of the job. Any discrepancies between plans and specification must be brought to the attention of the Designer.
- B. The Selected Vendor shall be prepared to, upon request by the Owner, provide actual samples of the furniture items, representing finishes and materials selections, at the Selected Vendor's expense, including shipping, of all items quoted in the specifications. Upon Owner approval of any sample, it shall be used as a quality control standard for the job, and may be incorporated as part of the work. This provision shall also apply to all acceptable alternates.

Section 3 - General Conditions Continued

- C. Within 7 working days after awarding of Bid and signed contract, the successful Vendor shall submit (1) sets of all material/finish samples (wood, fabric and/or metal finishes) to the Owner and the Specifier for all furnishings specified herein. All samples shall be signed and approved by the Owner and/or Specifier before Vendor may proceed with placement of order.
- D. The Selected Vendor shall submit shop drawings of those items shown (as required) in the specification and drawings, in the form of CAD/Revit and/or PDF, within two (2) working weeks after award of the contract from the Owner. These drawings shall be issued to the Designer via email prior to production.

Shop Drawings shall include the following:

- a. Cut sheets of all furniture
 - b. Memo/fabric swatches specified for each fabric/vinyl seating option
 - c. Field Verification of offices, workstations and technology tables for sizes and power/data locations.
- E. The Selected Vendor shall submit fabric order summaries of those items shown (as required) in the specification and drawings, stating dates of arrival at furniture manufacturing facility and approval of COM from furniture manufacturing facility, within one (1) working week after award of the contract from the Owner. **Proof of fabric approval and reservation of material shall be issued to the Designer via email for approval prior to production.**
- F. The Specifiers approval stamp on the shop drawings (where required) shall be considered as an approval of the general design appearance only. The approval shall not relieve the Selected Vendor of the responsibility for errors and omissions.

The Selected Vendor shall be responsible for the design and execution of necessary connections and details and for all dimensions on the shop drawings.

The Selected Vendor shall be responsible to correct all details on the drawings and complete work as may hereafter be found to be deficient in strength or faulty workmanship without any claim for extra payment from the Owner.

- G. Each and every individual carton or package delivered to the site shall have a packing list stating quantities and items being delivered for review and signature by the Selected Vendors on site project coordinator. A copy shall be furnished to the Owner for invoice verification purposes.
- H. The Selected Vendor shall be responsible for properly tagging all packing slips with the correct room number and furniture code (ie. LS10) as indicated on the Furniture Contract Documents and the Furniture Specifications prior to delivery and installation.

The Vendor shall be responsible for tagging in a visible place, all specified furniture with their Code Number and Room Number, as listed in the Specifications to ensure proper installation and placement.

The Owner may refuse unmarked items at the site. The Selected Vendor is responsible for locating and installing all specified furniture according to the Furniture Contract Documents. Upon delivery and installation in place of all furniture items, the Vendor shall furnish to the Owner's Representative, verification of exact quantities shipped and received.

Section 3 - General Conditions Continued

- I. The Selected Vendor shall provide suitable off-site space for storage of material and all such materials shall be properly protected from weather and theft.
- J. The Selected Vendor shall provide appropriate protection for all doorjambes and protection for the flooring (i.e. carpeting) and other finishes and furnishings during installation. The Selected Bidder shall consult with, and be responsible to the Owner, for all aspects of the furniture delivery and installation. The Selected Vendor shall coordinate his/her work with all other trades.
- K. The Vendor shall be held responsible for any damages, dents and marks to the product and the Owner's building, no matter how minor, caused by the movement of his materials labor or installation.
- L. The Vendor shall be responsible for preparation and protection of room surfaces and furnishings from damage, dust, dirt and other deleterious materials during all operations of the work. The Vendor shall provide complete cleaning of the installation for owner acceptance prior to move in.
- M. The Selected Vendor shall ensure that all materials delivered to the site will be delivered on schedule, and with the Owner's prior approval. All materials on site shall be arranged and maintained in a safe and orderly manner. The use of walks, drives, roads, and entrances shall be coordinated and scheduled in accordance with the General Contractor/Clark Construction's approved requirements.
- N. Materials delivered to the site shall not at any time be stacked or stored in a manner causing concentrated loads in the building.
- O. All unused material, rubbish, and equipment accumulated or required for completion of work shall be removed from the premises at the Vendor's expense on a daily basis. This includes all packaging materials.
- P. The Vendor shall assign to the Owner a Project Coordinator responsible for expediting, coordinating, and installation of all items. This individual shall be a full time employee of the Vendor, dedicated to the project through completion, and responsible for the following:
 - 1. Replace without additional cost to the Owner the defective unit with a satisfactory product, or
 - 2. Refund the Owner the sum of money paid for the unit found unsatisfactory and to make such disposition of the defective materials without additional cost to the Owner, or
 - 3. Reposition or reinstall any furniture which was not installed in accordance with the plans.
- Q. The selected Vendor shall provide for and coordinate all low voltage and electrical requirements with the General Contractor/Clark Construction and the Construction Schedule.

3.06 Owner Responsibilities:

- A. Owner/ Construction Manager shall inform the Vendor at least 10 working days prior to scheduled installation of any changes in the installation schedule.

Section 3 - General Conditions Continued

- B. The Owner/Construction Manager will establish the FINAL dates of substantial completion and final acceptance and will review written guarantees and related documents required by the contract and Vendor PRIOR to order entry.
- C. Except as otherwise stated, any direction, or approval required by the Furniture Contract Documents, as related to the intent of the specified furniture product, shall be given by the Designer.

3.07 Designer/Specifier Responsibilities:

- A. The Specifier does not guarantee or assume responsibility for the performance of the contract, work, or products of any Vendor or Sub-contractor retained by the Owner.
- B. Nothing in the Furniture Contract Documents shall be construed as giving the Specifier the authority to determine, direct, or supervise construction and/or installation methods, procedures or safety measures for the furniture installation; or responsibility for the Vendor's failure to carry out the work in accordance with the Flint Public Library Furniture Bid Package Contract Documents.
- C. The Specifier shall not be responsible for the acts or omissions of the Vendor, their agents, or any other person performing any of the work. In reviewing or approving the quality and progress of the work and submittals received from the Vendor, the Designer is acting solely for the convenience of the Owner and is not acting in capacity of inspector. The Specifier has no responsibility to assist the Vendor in the supervision or performance of the work.

3.08 Miscellaneous Provisions:

- A. The Owner is **NOT** exempt from local and state sales taxes. Prices quoted by the Vendor MUST include taxes.
- B. The Vendor shall be responsible for providing a complete furniture punch list, indicating any defects, deficiencies, or damages to the installed product, for review with the Owner's Representative and the Specifier prior to acceptance of the work. Final payment (in the form of a (20) twenty percent retainer) shall be paid to the Vendor subject to completion of all remedial punch list work.
- C. Claims, disputes, or other matters in question between the Bidder and the Owner relating to the interpretation of the Flint Public Library Furniture Bid Package Contract Documents, or the breach thereof, shall be submitted in writing to the other party. All such claims unable to be resolved to the mutual agreement of both parties shall be decided by binding arbitration, in accordance with applicable law.

3.09 Owners General Requirements

- A. Qualified craftsmen to be used in each trade. Workmanship shall be of the best standard practice and shall be subject to inspection by the Owner's Representative.

Section 3 - General Conditions Continued

- B. The Vendor shall inspect the job site when available and note access, elevators, doorways and openings necessary for complete installation of his part of the work. Site visits shall be scheduled with Clark Construction. If any conditions are present that would be detrimental to the proper installation of the specified furnishings, the Vendor must notify the Designer in writing.
- C. Any material not conforming to the specifications and approved samples shall be removed from the site of the work and replaced with approved materials at no cost to the Owner.
- D. The Vendor shall notify the Owner, and Clark Construction at least (10) ten working days in advance of starting any installation work in order to provide for inspection.
- E. Neither the completion of furniture installation, nor payment shall relieve the Vendor of responsibility for faulty materials or workmanship. Unless otherwise specified, the Vendor shall remedy any defects, which appear within a period of one year from the date of written acceptance.

Furniture damaged during normal course of use shall not be the Vendor's responsibility, providing the product was obtained and installed according to the specifications.

- F. The Vendor shall verify all quantities quoted on the plans. The Vendor shall verify all critical dimensions of furniture on the job.

In the event that the Vendor shall discover discrepancies in quantities or dimensions, notification must be given immediately to the Designer and Owner and the total contract cost will be adjusted accordingly by mutual agreement.

- G. Items not coded on plans or listed herein are not part of this Contract.
- H. The Vendor shall be responsible for any damages incurred in shipment from manufacturer to Vendor's warehousing facility, storage facility, or to the project site location.
- I. The Vendor will place in position, each item according to location as shown on the Furniture Floor Plans ID110, ID111 and ID112. Each item shall be aligned and leveled to the satisfaction of the the Owner and OPN Architects.
- J. Upon completion of furniture installation, all rooms must be cleared of packing materials and other debris resulting from the installation. All items must be cleaned and ready for use by Owner.
- K. The Vendor shall not assign the whole or any part of this agreement, or any monies due or to become due hereunder, without written consent of the Owner, and all sureties executing any bonds on behalf of the Vendor in connection with said agreement.

Any assignment made without such consent shall be null and void, and the assignee shall acquire no rights thereby.

Section 3 - General Conditions Continued

3.10 Payments and Completion:

- A. If a discrepancy occurs between the unit price and extended price of a furnishings item quoted, the Vendor shall be bound by the unit price amount.
- B. The Vendor agrees that the unit price listed on the bid proposal will apply in the event that changes, plus or minus 20% of the total quantities of specified items, are authorized by written change order from the Owner to the Vendor.
- C. Unit List prices are based on providing all furniture products, in accordance with all applicable requirements of the Furniture Contract Documents. Unit Net prices shall indicate Bidders discounts as applicable to the project. Deposit, Delivery, and installation cost shall be separated out from the unit prices. Bidders shall submit a pricing summary including all information as indicated on the Furniture Bid Form document, included herewith.
- D. If the Vendor is delayed at any time in the progress of the work by any act of neglect of the Owner, by labor disputes, fire, unavoidable casualties, or any cause beyond the Vendor's control, or by delay authorized by the Owner, then the substantial completion time shall be extended by written change order for such time as is mutually agreed upon by the Owner and the Vendor.
- E. All claims for extension of time for delays not caused by the Owner or any of the above mentioned causes shall be made in writing to the Owner no more than three (3) working days after the occurrence of the delay.
- F. The Vendor warrants and guarantees that title to all work and materials covered by final payment will pass to the Owner upon receipt of such payment by the Vendor.
- G. Application for payment shall be made based on delivery and installation.
- H. Application for final payment shall be made at final acceptance of the work.
 - a. No payments made to the Vendor shall be construed as an acceptance of any work or material not in accordance with the Furniture Contract Documents.
- I. Final acceptance and payments will be made after final review of the project by the Owner and Architect, provided that all requirements of the Furniture Contract Documents have been completed.

End of General Conditions Section 3

Section 4 - Supplemental Conditions

Construction Facilities and Temporary Controls:

- A. Temporary Electricity: Connect to existing power service. Power consumption shall not disrupt Owner's need for continuous service. Owner will pay cost of energy used.
- B. Temporary Heat: Owner will pay cost of energy used. Exercise measures to conserve energy.
- C. Temporary Ventilation: Ventilate enclosed areas to assist cure of materials, to dissipate humidity, and to prevent accumulation of dust, fumes, vapors, or gases.
- D. Temporary Lighting: Permanent building lighting may be utilized during construction.
- E. Temporary Water Service: Owner will pay cost of water used. Exercise measures to conserve water.
- F. Temporary Sanitary Facilities: Existing designated facilities may be used during construction operations. Maintain daily in clean and sanitary condition. Coordinate with Clark Construction.
- G. Parking: To be coordinated with Clark Construction PRIOR to all scheduled delivery/installation.
- H. Progress Cleaning: Maintain areas free of waste materials, debris, and rubbish. Maintain site in a clean and orderly fashion.
- I. Final Cleaning: The Vendor shall provide complete cleaning of the installation for Owner approval prior to final acceptance and move in.

End of Supplemental Conditions Section 4

Section 5 - Proposal for Furniture Bid Package

Bidder Information

Incorporated in the State of:

Contact:

Name:

Address:

Telephone:

Date:

The Undersigned, having carefully studied the plans, specifications and the Furniture Contract Documents prepared by OPN Architects, Inc., do hereby offer to perform the work required for the Flint Public Library Furniture Bid Package in accordance with the Furniture Bid Package Contract April 9, 2021, including all addenda issued prior to date of opening of proposals which is / are hereby acknowledged.

1. Furniture Bid Forms:

The Undersigned shall have broken down all bids on an item-by-item basis per the provided Furniture Bid Forms in accordance with the bid submittal criteria and direction given in the Instructions to Bidders, the General Conditions, and the Supplemental Conditions.

The Undersigned shall have listed all Furniture Codes, Furniture Types, Quantities, Discount Information, Unit List cost, Unit Net Cost, Extended Costs, Delivery / Installation Charges, Lead Time and Schedule Information, and the lump sum total bid in the Furniture Bid Forms section of the specifications.

2. Schedule of Unit Costs:

The Undersigned agrees that the Unit Net Costs listed on the Furniture Bid Form will apply in the event that changes, up to plus or minus 20% of the total quantities in the work to be performed under the Contract, are authorized by written order from the Owner to the Undersigned.

The Undersigned further agrees to support the Unit Costs listed herein and modifications thereto for the duration of the project phasing to provide a complete and finished product.

The Unit Costs are based on providing all work complete in place and in accordance with all applicable requirements of the Furniture Contract Documents, and include all of the Undersigned's Costs.

Section 5 - Proposal for Furniture Bid Package Continued

3. Acceptance of Bids

The Undersigned agrees that the Owner may hold this bid for a period not exceeding (120) one hundred twenty days from the date of receipt. All prices must be quoted delivered FOB. Forty-eight (48) hour notice prior to any delivery of merchandise is required. Notice shall be given to the Owners Representative.

It is understood and agreed that Owner reserves the right to award the contract according to his/her best interest, to reject any or all bids, and to waive any formalities in bidding.

The Owner may accept or reject any or all of the unit prices prior to the execution of the contract.

4. Time for Completion of Work

The Undersigned agrees, if awarded this contract, to commence and complete the work in accordance with the dates established in the Installation Schedule, and in accordance with the move schedule to be agreed upon with the Owner upon award of the bid.

5. Coordination of Work

The Undersigned agrees to cooperate with the Construction Manager of the building to anticipate when specific areas of concern under this Contract will become available in the schedule of completion with all other contractors and utility companies to assure proper coordination of the work.

6. Bid Submission

The Undersigned shall submit the bid, including the itemized breakdown and unit prices on the Furniture Bid Forms as supplied with the specifications, and in the spaces provided on this Bid Proposal Form.

The Undersigned acknowledges all Bids must be signed and sent electronically by the indicated due date and time to OPN Architects. Please identify the project RFQ # in the subject line:

RFQ# 17215000
Flint Public Library Furniture Bid Package

Submitted by:

Firm's Name

Incorporated in the State of:

By:

Title:

End of Proposal for Furniture Section 5

Section 6 – Upholstery Special Instructions

1. All specified upholsteries are to be from the same dye lot.
2. Submit cuttings for approval by Designer/Specifier from proposed dye lots prior to production.
3. The Vendor(s) are to coordinate the reservations of all upholstery fabrics within
4. Same dye lots to meet furniture fabrication lead times for the entire project.
5. Vendor is to provide Owner with written cleaning and maintenance instructions at time of installation.
6. All upholstery has been graded-in and/or is approved for products in this project.
7. Proof of fabric approval and reservation of material shall be issued to the Designer within 7 days after contract is awarded via email for approval prior to order entry. Confirmation will need to be documented and issued again 10 weeks prior to installation. Vendor will be held responsible for any, and all cost increases to the project to ensure specified product/fabric will install per contract dates provided for substantial completion.

End of Upholstery Special Instructions – Section 6

Item Information

Section Number 7.0
Item Code TA-1
Manufacturer 3Branch
Model Skware Table
Model Number SK-4242
Dimensions 42"D. x 42"W. x 29.5"H.
Description Seated height table with quartz top.
Special Instructions --

Item Options

Top Finish Corian Quartz - Nebula
Base Finish Brushed Stainless Steel

Item Locations/Counts

ROOM NUMBER	ROOM NAME	COUNT
LOWER LEVEL		
116	BREAK ROOM	2
132	LOCAL HISTORY & GENEALOGY	1
MAIN LEVEL		
202	ADULT - FICTION	1
204	STUDY ROOM	1
205	STUDY ROOM	1
206	STUDY ROOM	1
207	STUDY ROOM	1
UPPER LEVEL		
305	CAFE	4
COUNT TOTAL		12



Substitution Requests Accepted: Yes

Note: Image(s) may not depict exact product or finishes, see item options.



Sheet Name
Furniture Specifications
Project
FLINT PUBLIC LIBRARY RENOVATION
1026 E. Kearsley St.,
Flint, MI 48503

OPN Project No. **17215000**
Sheet Issue Date **4/28/2021**
Section Number **7.0**
Item Code **TA-1**

Item Information

Section Number 7.0
 Item Code TA-2
 Manufacturer 3Branch
 Model Skware Table
 Model Number SK-4242
 Dimensions 42"D. x 42"W. x 29.5"H.
 Description Seated height table with quartz top and power in table top.
 Special Instructions Provide shop drawings for final location of power module

Item Options

Top Finish Corian Quartz - Nebula -
 Base Finish Brushed Stainless Steel -
 Table Accessories Byrne Eclipse 3 Power Module - Soft
 Touch White Plastic
 Wire Management Leg - WML-3036

Item Locations/Counts

ROOM NUMBER	ROOM NAME	COUNT
LOWER LEVEL		
132	LOCAL HISTORY & GENEALOGY	2
MAIN LEVEL		
202	ADULT - FICTION	3
UPPER LEVEL		
302	ADULT - NON FICTION	3
305	CAFE	2
327	READING ROOM	1
COUNT TOTAL		11

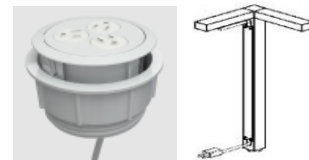

Substitution Requests Accepted: Yes

Note: Image(s) may not depict exact product or finishes, see item options.



Sheet Name
Furniture Specifications
 Project
FLINT PUBLIC LIBRARY RENOVATION
 1026 E. Kearsley St.,
 Flint, MI 48503

OPN Project No. **17215000**
 Sheet Issue Date **4/28/2021**
 Section Number **7.0**
 Item Code **TA-2**

Item Information

Section Number 7.0
 Item Code TA-3
 Manufacturer 3Branch
 Model Skware Table
 Model Number SK-7242
 Dimensions 42"D. x 72"W. x 29.5"H.
 Description Seated height table with quartz top and power in table top.
 Special Instructions Provide shop drawings for final location of power module

Item Options

Top Finish Corian Quartz - Nebula -
 Base Finish Brushed Stainless Steel -
 Table Accessories Byrne Eclipse 3 Power Module - Soft
 Touch White Plastic
 Wire Management Leg - WML-3036

Item Locations/Counts

ROOM NUMBER	ROOM NAME	COUNT
LOWER LEVEL		
105	CONFERENCE ROOM	1
UPPER LEVEL		
313	MEETING ROOM	1
328	STUDY ROOM	1
329	STUDY ROOM	1
330	STUDY ROOM	1
COUNT TOTAL		5

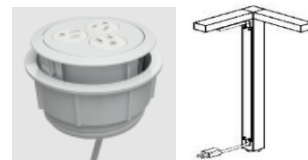

Substitution Requests Accepted: Yes

Note: Image(s) may not depict exact product or finishes, see item options.



Sheet Name
Furniture Specifications
 Project
FLINT PUBLIC LIBRARY RENOVATION
 1026 E. Kearsley St.,
 Flint, MI 48503

OPN Project No. **17215000**
 Sheet Issue Date **4/28/2021**
 Section Number **7.0**
 Item Code **TA-3**

Item Information

Section Number 7.0
Item Code TA-4
Manufacturer 3Branch
Model Skware Occasional Table - Round Top
Model Number Round Base
Dimensions SK-OCC-36-16-RB
Description 36" Dia. X 16" H.
Round occasional table with quartz top and power in table top.
Special Instructions Provide shop drawings for final location of power module

Item Options

Top Finish Corian Quartz - Nebula -
Base Finish Brushed Stainless Steel -
Table Accessories Byrne Eclipse 3 Power Module - Soft
Touch White Plastic
Wire Management Leg - WML-3036

Item Locations/Counts

ROOM NUMBER	ROOM NAME	COUNT
LOWER LEVEL		
102	PROJECT ROOM	1
COUNT TOTAL		1

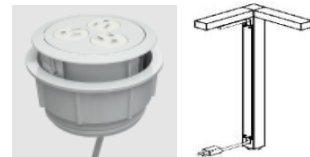
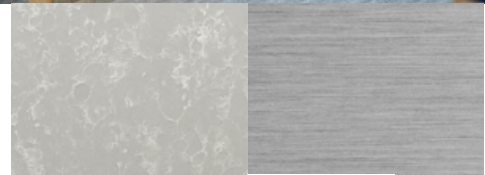

Substitution Requests Accepted: Yes

Note: Image(s) may not depict exact product or finishes, see item options.



Sheet Name
Furniture Specifications
Project
FLINT PUBLIC LIBRARY RENOVATION
1026 E. Kearsley St.,
Flint, MI 48503

OPN Project No. **17215000**
Sheet Issue Date **4/28/2021**
Section Number **7.0**
Item Code **TA-4**

Item Information

Section Number 7.0
Item Code TA-5
Manufacturer 3Branch
Model Skware Occasional Table - Round Top Round Base
Model Number SK-OCC-24-22-RB
Dimensions 24" Dia. X 22" H.
Description Round occasional table with quartz top.
Special Instructions --

Item Options

Top Finish Corian Quartz - Nebula
Base Finish Brushed Stainless Steel

Item Locations/Counts

ROOM NUMBER	ROOM NAME	COUNT
LOWER LEVEL		
101	STAFF	2
COUNT TOTAL		2



Substitution Requests Accepted: Yes

Note: Image(s) may not depict exact product or finishes, see item options.



Sheet Name
Furniture Specifications
Project
FLINT PUBLIC LIBRARY RENOVATION
1026 E. Kearsley St.,
Flint, MI 48503

OPN Project No. **17215000**
Sheet Issue Date **4/28/2021**
Section Number **7.0**
Item Code **TA-5**

Item Information

Section Number 7.0
Item Code TA-6
Manufacturer 3Branch
Model Skware Occasional Table - Round Top Round Base
Model Number SK-OCC-20-22-RB
Dimensions 20" Dia. X 22" H.
Description Round occasional table with quartz top.
Special Instructions --

Item Options

Top Finish Corian Quartz - Nebula
Base Finish Brushed Stainless Steel

Item Locations/Counts

ROOM NUMBER	ROOM NAME	COUNT
LOWER LEVEL		
116	BREAK ROOM	3
124	MOTHER'S ROOM	1
MAIN LEVEL		
228	NEW MOM'S RM	1
UPPER LEVEL		
306	PUBLIC ACCESS COMPUTERS	2
COUNT TOTAL		7



Substitution Requests Accepted: Yes

Note: Image(s) may not depict exact product or finishes, see item options.



Sheet Name
Furniture Specifications
Project
FLINT PUBLIC LIBRARY RENOVATION
1026 E. Kearsley St.,
Flint, MI 48503

OPN Project No. **17215000**
Sheet Issue Date **4/28/2021**
Section Number **7.0**
Item Code **TA-6**

Item Information

Section Number 7.0
Item Code TA-7
Manufacturer 3Branch
Model Skware Occasional Table - Round Top Round Base
Model Number SK-OCC-30-16-RB
Dimensions 30" Dia. X 16" H.
Description Round occasional table with quartz top.
Special Instructions --

Item Options

Top Finish Corian Quartz - Nebula
Base Finish Brushed Stainless Steel

Item Locations/Counts

ROOM NUMBER	ROOM NAME	COUNT
MAIN LEVEL		
202	ADULT - FICTION	1
203	STUDY ROOM	1
208	STUDY ROOM	1
221	MEETING ROOM	1
UPPER LEVEL		
301	LOBBY	2
302	ADULT - NON FICTION	3
533	GALLERY	1
COUNT TOTAL		10



Substitution Requests Accepted: Yes

Note: Image(s) may not depict exact product or finishes, see item options.



Sheet Name
Furniture Specifications
Project
FLINT PUBLIC LIBRARY RENOVATION
1026 E. Kearsley St.,
Flint, MI 48503

OPN Project No. **17215000**
Sheet Issue Date **4/28/2021**
Section Number **7.0**
Item Code **TA-7**

Item Information

Section Number 7.0
Item Code TA-8
Manufacturer 3Branch
Model Skware Occasional Table - Round Top
Model Number Round Base
Dimensions SK-OCC-30-16-RB
Description 30" Dia. X 16" H.
Round occasional table with quartz top and power in table top.
Special Instructions Provide shop drawings for final location of power module

Item Options

Top Finish Corian Quartz - Nebula -
Base Finish Brushed Stainless Steel -
Table Accessories Byrne Eclipse 3 Power Module -
Soft Touch White Plastic
Wire Management Leg - WML-3036

Item Locations/Counts

ROOM NUMBER	ROOM NAME	COUNT
MAIN LEVEL		
202	ADULT - FICTION	5
209	YOUNG ADULT	3
UPPER LEVEL		
302	ADULT - NON FICTION	4
327	READING ROOM	2
COUNT TOTAL		14



Substitution Requests Accepted: Yes

Note: Image(s) may not depict exact product or finishes, see item options.



Sheet Name
Furniture Specifications
Project
FLINT PUBLIC LIBRARY RENOVATION
1026 E. Kearsley St.,
Flint, MI 48503

OPN Project No. **17215000**
Sheet Issue Date **4/28/2021**
Section Number **7.0**
Item Code **TA-8**

Item Information

Section Number 7.0
Item Code TA-9
Manufacturer 3Branch
Model Skware Occasional Table - Rectangle
Model Number SK-OCC-4830-16
Dimensions 48"W. X 30"D. X 16"H.
Description Rectangle occasional table with quartz top and power in table top.
Special Instructions Provide shop drawings for final location of power module

Item Options

Top Finish Corian Quartz - Nebula -
Base Finish Brushed Stainless Steel -
Table Accessories Byrne Eclipse 3 Power Module -
Soft Touch White Plastic
Wire Management Leg - WML-3036

Item Locations/Counts

ROOM NUMBER	ROOM NAME	COUNT
MAIN LEVEL		
202	ADULT - FICTION	2
UPPER LEVEL		
327	READING ROOM	2
COUNT TOTAL		4

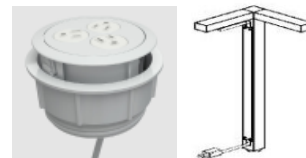
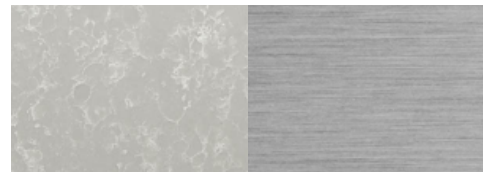

Substitution Requests Accepted: Yes

Note: Image(s) may not depict exact product or finishes, see item options.

Item Information

Section Number 7.0
Item Code TA-10
Manufacturer 3Branch
Model Maker Flex Table - Maple Butcher Block top - nesting / adjustable height
Model Number MF-6624-NEST-ADJT-BBK-CAS
Dimensions 66"W. X 24"D. X 27"-41"H.
Description Butcher block table with Flip-top, hand-crank, adjustable height (29" - 41" AFF) / caster base.
Special Instructions --

Item Options

Top Finish Maple Butcher Block
Base Finish Platinum Metallic powder coat

Item Locations/Counts

ROOM NUMBER	ROOM NAME	COUNT
UPPER LEVEL		
308	DIGITAL MEDIA LAB	12
309	DIGITAL MEDIA/ MAKER LAB	9
311	STORAGE	3
COUNT TOTAL		24



Substitution Requests Accepted: Yes

Note: Image(s) may not depict exact product or finishes, see item options.



Sheet Name
Furniture Specifications
Project
FLINT PUBLIC LIBRARY RENOVATION
1026 E. Kearsley St.,
Flint, MI 48503

OPN Project No. **17215000**
Sheet Issue Date **4/28/2021**
Section Number **7.0**
Item Code **TA-10**

Item Information

Section Number 7.0
Item Code TA-11
Manufacturer 3Branch
Model Maker Flex Kid's Table - Maple Butcher Block top - nesting / adjustable height
Model Number MFC-6630-NEST-ADJT-BBK-CAS
Dimensions 66"W. X 30"D. X 24"-34"H.
Description Children's height butcher block table with Flip-top, hand-crank, adjustable height (29" - 41" AFF) / caster base.
Special Instructions --

Item Options

Top Finish Maple Butcher Block
Base Finish Platinum Metallic powder coat

Item Locations/Counts

ROOM NUMBER	ROOM NAME	COUNT
MAIN LEVEL		
222	CHILDREN'S PROGRAM ROOM	6
COUNT TOTAL		6



Substitution Requests Accepted: Yes

Note: Image(s) may not depict exact product or finishes, see item options.



Sheet Name
Furniture Specifications
Project
FLINT PUBLIC LIBRARY RENOVATION
1026 E. Kearsley St.,
Flint, MI 48503

OPN Project No. **17215000**
Sheet Issue Date **4/28/2021**
Section Number **7.0**
Item Code **TA-11**

Item Information

Section Number 7.0
Item Code TA-12
Manufacturer 3Branch
Model Maker Table - Fixed top - Adjustable Height
Model Number MK-7230ADJ-BBK
Dimensions 72"W. X 30"D. X 29"-41"H.
Description Butcher block table with adjustable height legs and heavy duty casters.
Special Instructions --

Item Options

Top Finish Maple Butcher Block
Base Finish Brushed Stainless Steel

Item Locations/Counts

ROOM NUMBER	ROOM NAME	COUNT
LOWER LEVEL		
125	SHIPPING & RECEIVING	1
135	TECH SERVICES/ LOAN WORK ROOM	1
COUNT TOTAL		2



Substitution Requests Accepted: Yes

Note: Image(s) may not depict exact product or finishes, see item options.



Sheet Name
Furniture Specifications
Project
FLINT PUBLIC LIBRARY RENOVATION
1026 E. Kearsley St.,
Flint, MI 48503

OPN Project No. **17215000**
Sheet Issue Date **4/28/2021**
Section Number **7.0**
Item Code **TA-12**

Item Information

Section Number 7.0
Item Code TA-13
Manufacturer 3Branch
Model Maker Storage Table - Counter Height
Model Number MST-663036-CMB/BBK
Dimensions 66"W. X 30"D. X 36"H.
Description Butcher block table with storage combination of cabinet and drawer modules and with heavy duty casters.
Special Instructions --

Item Options

Top Finish Maple Butcher Block
Base Finish Brushed Stainless Steel
Cabinet/Drawer Finish Wilsonart - Kensington Maple

Item Locations/Counts

ROOM NUMBER	ROOM NAME	COUNT
LOWER LEVEL		
125	SHIPPING & RECEIVING	1
135	TECH SERVICES/ LOAN WORK ROOM	1
COUNT TOTAL		2



Substitution Requests Accepted: Yes

Note: Image(s) may not depict exact product or finishes, see item options.



Sheet Name
Furniture Specifications
Project
FLINT PUBLIC LIBRARY RENOVATION
1026 E. Kearsley St.,
Flint, MI 48503

OPN Project No. **17215000**
Sheet Issue Date **4/28/2021**
Section Number **7.0**
Item Code **TA-13**

Item Information

Section Number 7.0
Item Code TA-31
Manufacturer 3Branch
Model Skware Table
Model Number SK-3024
Dimensions 30"W. X 24"D. X 29.5"H.
Description Seated height table with quartz top.
Special Instructions --

Item Options

Top Finish Corian Quartz - Nebula
Base Finish Brushed Stainless Steel

Item Locations/Counts

ROOM NUMBER	ROOM NAME	COUNT
MAIN LEVEL		
212	CHILDREN'S COLLECTION	1
COUNT TOTAL		1

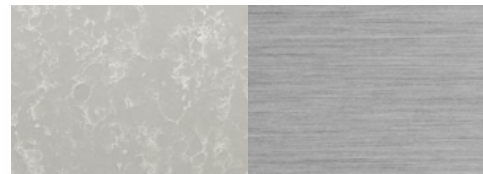

Substitution Requests Accepted: Yes

Note: Image(s) may not depict exact product or finishes, see item options.



Sheet Name
Furniture Specifications
Project
FLINT PUBLIC LIBRARY RENOVATION
1026 E. Kearsley St.,
Flint, MI 48503

OPN Project No. **17215000**
Sheet Issue Date **4/28/2021**
Section Number **7.0**
Item Code **TA-31**

Item Information

Section Number 8.0
Item Code POD-1
Manufacturer Agati
Model The Pod
Model Number POD-WKS-STR-52-49-ELE-UPS
Dimensions 52" Dia. X 49"H X 19" SH.
Description Single Faced 1 Person Work Station with upholstered surrounds, fixed bench with cushioned seat and back, plastic laminate work surface and side shelf, PVC edgeband, and metal leg base with clear anodized aluminum finish. Includes 1 surface mount power pop outlet. 4-Trac hardwired power connection.

Special Instructions --

Item Locations/Counts

ROOM NUMBER	ROOM NAME	COUNT
UPPER LEVEL		
306	PUBLIC ACCESS COMPUTERS	5
COUNT TOTAL		5

Item Options

Surround Fabric HBF - Color Code - 84 Warm Grey
Bench Fabric CF Stinson - Nishiki 2.0 - 263 Bamboo
Work Surface Finish Formica - White 949-58



Substitution Requests Accepted: Yes

Note: Image(s) may not depict exact product or finishes, see item options.



Sheet Name
Furniture Specifications
Project
FLINT PUBLIC LIBRARY RENOVATION
1026 E. Kearsley St.,
Flint, MI 48503

OPN Project No. **17215000**
Sheet Issue Date **4/28/2021**
Section Number **8.0**
Item Code **POD-1**

Item Information

Section Number 9.0
Item Code O-1
Manufacturer Allermuir
Model Pebble Ottoman - Table Topped Unit
Model Number A622
Dimensions --
Description Upholstered ottoman with metal legs and laminate table top.
Special Instructions --

Item Options

Fabric Designtex - Rove - Ochre
Metal Leg Finish Silver
Grade A Laminate White
Linking Bracket Yes

Item Locations/Counts

ROOM NUMBER	ROOM NAME	COUNT
MAIN LEVEL		
212	CHILDREN'S COLLECTION	2
COUNT TOTAL		2

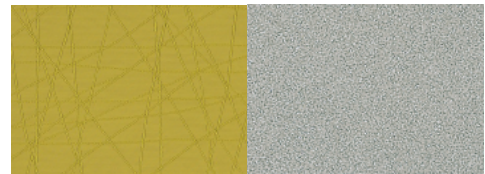

Substitution Requests Accepted: Yes

Note: Image(s) may not depict exact product or finishes, see item options.



Sheet Name
Furniture Specifications
Project
FLINT PUBLIC LIBRARY RENOVATION
1026 E. Kearsley St.,
Flint, MI 48503

OPN Project No. **17215000**
Sheet Issue Date **4/28/2021**
Section Number **9.0**
Item Code **O-1**

Item Information

Section Number 9.0
Item Code O-2
Manufacturer Allermuir
Model Pebble Ottoman - Scalloped stool
Model Number A621
Dimensions --
Description Upholstered nesting ottoman.
Special Instructions --

Item Options

Fabric Designtex - Rove - Teal
Metal Leg Finish Silver
Linking Bracket Yes

Item Locations/Counts

ROOM NUMBER	ROOM NAME	COUNT
MAIN LEVEL		
212	CHILDREN'S COLLECTION	2
COUNT TOTAL		2

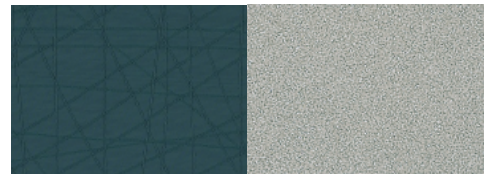

Substitution Requests Accepted: Yes

Note: Image(s) may not depict exact product or finishes, see item options.



Sheet Name
Furniture Specifications
Project
FLINT PUBLIC LIBRARY RENOVATION
1026 E. Kearsley St.,
Flint, MI 48503

OPN Project No. **17215000**
Sheet Issue Date **4/28/2021**
Section Number **9.0**
Item Code **O-2**

Item Information

Section Number 9.0
Item Code O-3
Manufacturer Allermuir
Model Pebble Ottoman - Scalloped stool
Model Number A621
Dimensions --
Description Upholstered nesting ottoman.
Special Instructions --

Item Options

Fabric Designtex - Rise - Gunmetal
Metal Leg Finish Silver
Linking Bracket Yes

Item Locations/Counts

ROOM NUMBER	ROOM NAME	COUNT
MAIN LEVEL		
212	CHILDREN'S COLLECTION	3
COUNT TOTAL		3

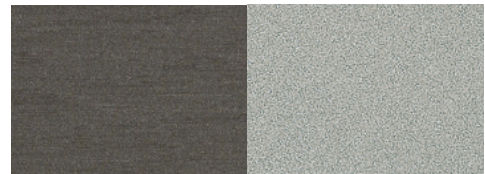

Substitution Requests Accepted: Yes

Note: Image(s) may not depict exact product or finishes, see item options.



Sheet Name
Furniture Specifications
Project
FLINT PUBLIC LIBRARY RENOVATION
1026 E. Kearsley St.,
Flint, MI 48503

OPN Project No. **17215000**
Sheet Issue Date **4/28/2021**
Section Number **9.0**
Item Code **O-3**

Item Information

Section Number 10.0
Item Code TA-16
Manufacturer Allsteel
Model Harvest Classic Powered Table
(top and base) - Bar height
Model Number S913LTS4296
S913LPB4242
Dimensions 96"W. X 42"D X 42"H.
Description Powered (corded) bar height table with split
top in laminate finish. Power access on top and sides.
Special Instructions --

Item Options

Electrical Option Corded -
Laminate Finish Wilsonart - Phantom Charcoal -
Paint Finish (trough) Flint -
Power Module S913P110LS (Starter Cord) -
Power Module S913PLE (Interlink End Cond Pwr Mod)
- Quantity: 2
Power Module S913PLM (Interlink Mid Surf Pwr Mod)
- Quantity: 4

Item Locations/Counts

ROOM NUMBER	ROOM NAME	COUNT
MAIN LEVEL		
209	YOUNG ADULT	1
COUNT TOTAL		1



Substitution Requests Accepted: Yes

Note: Image(s) may not depict exact product or finishes, see item options.

Item Information

Section Number 11.0
Item Code B-1
Manufacturer Arcadia
Model Allsorts Two-Seat Bench with Back
Model Number 7852.0
Dimensions 62"W. X 33"D.
Description Upholstered bench with back. Contrasting fabrics on seat and back.
Special Instructions *Provide NANOTEX POLY/OLEFIN WITH BACKING for Sina Pearson - Landscape.*

Item Options

Wood Platform Finish 166 Smoky Umber Ash -
Seat Fabric Designtex - Rise - Night
Back Fabric Sina Pearson - Landscape -
26 Amaranth

Item Locations/Counts

ROOM NUMBER	ROOM NAME	COUNT
MAIN LEVEL		
220	SNACK AREA	2
COUNT TOTAL		2

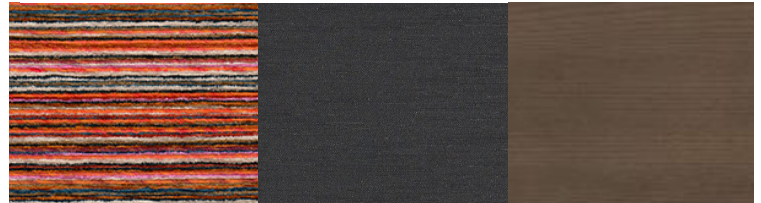

Substitution Requests Accepted: Yes

Note: Image(s) may not depict exact product or finishes, see item options.



Sheet Name
Furniture Specifications
Project
FLINT PUBLIC LIBRARY RENOVATION
1026 E. Kearsley St.,
Flint, MI 48503

OPN Project No. **17215000**
Sheet Issue Date **4/28/2021**
Section Number **11.0**
Item Code **B-1**

Item Information

Section Number 12.0
Item Code A-2
Manufacturer BCI
Model Crossrunner Book Trolley, WE12
Model Number B 7836 .00 BW
Dimensions --
Description Book cart.
Special Instructions --

Item Options

Protection Rings Yes -
Case Color Traffic White - 0332
Metal Color Grey Aluminum - RAL 9007

Item Locations/Counts

ROOM NUMBER	ROOM NAME	COUNT
LOWER LEVEL		
132	LOCAL HISTORY & GENEALOGY	2
MAIN LEVEL		
202	ADULT - FICTION	4
212	CHILDREN'S COLLECTION	2
UPPER LEVEL		
302	ADULT - NON FICTION	1
306	PUBLIC ACCESS COMPUTERS	1
COUNT TOTAL		10



Substitution Requests Accepted: Yes

Note: Image(s) may not depict exact product or finishes, see item options.

Item Information

Section Number 13.0
Item Code CH-1
Manufacturer Bernhardt
Model Chloe Guest Chair
Model Number chloe 1020
Dimensions --
Description Upholstered chair with chrome legs.
Special Instructions --

Item Options

Fabric Wolf Gordon - Tallinn - Nightfall
Metal Leg Finish 1020 - Chrome Tubular Steel

Item Locations/Counts

ROOM NUMBER	ROOM NAME	COUNT
LOWER LEVEL		
132	LOCAL HISTORY & GENEALOGY	8
134	SPECIAL COLLECTIONS	4
COUNT TOTAL		12



Substitution Requests Accepted: Yes

Note: Image(s) may not depict exact product or finishes, see item options.



Sheet Name
Furniture Specifications
Project
FLINT PUBLIC LIBRARY RENOVATION
1026 E. Kearsley St.,
Flint, MI 48503

OPN Project No. **17215000**
Sheet Issue Date **4/28/2021**
Section Number **13.0**
Item Code **CH-1**

Item Information

Section Number 13.0
Item Code LC-1
Manufacturer Bernhardt
Model Diego Lounge Chair
Model Number 5682.0
Dimensions --
Description Fully upholstered lounge chair with pull tab and weight-activated, self-locking casters.
Special Instructions --

Item Options

Fabric Wolf Gordon - East Village - Reef

Item Locations/Counts

ROOM NUMBER	ROOM NAME	COUNT
LOWER LEVEL		
212	CHILDREN'S COLLECTION	2
COUNT TOTAL		2



Substitution Requests Accepted: Yes

Note: Image(s) may not depict exact product or finishes, see item options.



Sheet Name
Furniture Specifications
Project
FLINT PUBLIC LIBRARY RENOVATION
1026 E. Kearsley St.,
Flint, MI 48503

OPN Project No. **17215000**
Sheet Issue Date **4/28/2021**
Section Number **13.0**
Item Code **LC-1**

Item Information

Section Number 13.0
Item Code LC-2
Manufacturer Bernhardt
Model Mitt Lounge Chair
Model Number 5721.0
Dimensions --
Description Upholstered lounge chair with weight-activated, self-locking casters. Standard stitch - no handle.
Special Instructions --

Item Options

Fabric Arc-Com - Insight - Mist #21

Item Locations/Counts

ROOM NUMBER	ROOM NAME	COUNT
MAIN LEVEL		
209	YOUNG ADULT	3
COUNT TOTAL		3



Substitution Requests Accepted: Yes

Note: Image(s) may not depict exact product or finishes, see item options.

Item Information

Section Number 13.0
Item Code O-4
Manufacturer Bernhardt
Model Colours 9 Modular Ottoman
Model Number 4839.0
Dimensions --
Description Fully upholstered ottoman with connecting module.
Special Instructions Requires 15% fabric overage due to repeat.

Item Options

Fabric Carnegie - Dotty Print - 3.0

Item Locations/Counts

ROOM NUMBER	ROOM NAME	COUNT
LOWER LEVEL		
212	CHILDREN'S COLLECTION	1
COUNT TOTAL		1

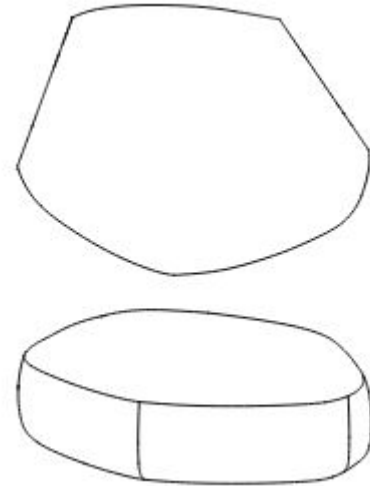

Substitution Requests Accepted: Yes

Note: Image(s) may not depict exact product or finishes, see item options.

Item Information

Section Number 13.0
Item Code O-5
Manufacturer Bernhardt
Model Colours 10 Modular Ottoman
Model Number 4840.0
Dimensions --
Description Fully upholstered ottoman with connecting module.
Special Instructions Requires 15% fabric overage due to repeat.

Item Options

Fabric Carnegie - Dotty Print - 3.0

Item Locations/Counts

ROOM NUMBER	ROOM NAME	COUNT
LOWER LEVEL		
212	CHILDREN'S COLLECTION	1
COUNT TOTAL		1

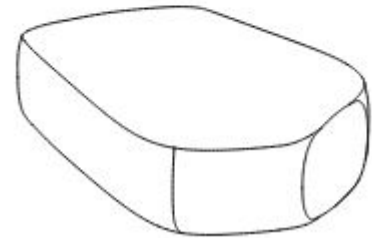
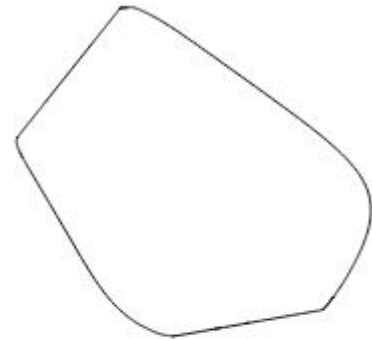

Substitution Requests Accepted: Yes

Note: Image(s) may not depict exact product or finishes, see item options.

Item Information

Section Number 13.0
Item Code O-6
Manufacturer Bernhardt
Model Colours 5 Modular Ottoman
Model Number 4835.0
Dimensions --
Description Fully upholstered ottoman with connecting module.
Special Instructions Requires 15% fabric overage due to repeat.

Item Options

Fabric Carnegie - Dotty Print - 3.0

Item Locations/Counts

ROOM NUMBER	ROOM NAME	COUNT
LOWER LEVEL		
212	CHILDREN'S COLLECTION	1
COUNT TOTAL		1

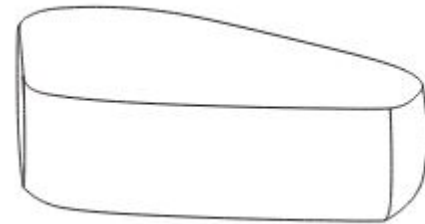
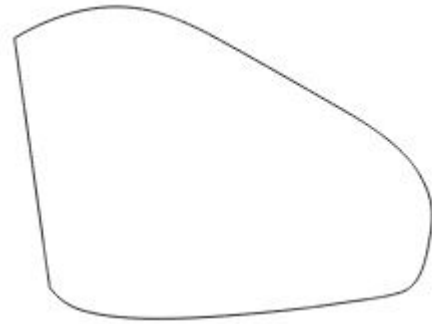

Substitution Requests Accepted: Yes

Note: Image(s) may not depict exact product or finishes, see item options.



Sheet Name
Furniture Specifications
Project
FLINT PUBLIC LIBRARY RENOVATION
1026 E. Kearsley St.,
Flint, MI 48503

OPN Project No. **17215000**
Sheet Issue Date **4/28/2021**
Section Number **13.0**
Item Code **O-6**

Item Information

Section Number 13.0
Item Code TA-17A
Manufacturer Bernhardt
Model Blueprint Table - Loop Stepped Configuration
- Stepped Table (bar height)
Model Number BPS-NMB-BCSQA28 WLT 870
Dimensions 108"W. X 42"D. X 42"H.
Description Wood table with stepped configuration - one side at bar height, one side at seated height. Power integration in table top.
Special Instructions Coordinate surface mount power location with designer.

Item Options

Series BPS -
SKU NMB -
Base BC - Loop/Block Base
Corner SQ - Square
Power A28 - Surface Mount Power Kit -
Black Finish
Base Material WLT - Walnut
Base Finish 870 -
Top Material WLT - Walnut
Top Finish 870

Item Locations/Counts

ROOM NUMBER	ROOM NAME	COUNT
LOWER LEVEL		
132	LOCAL HISTORY & GENEALOGY	2
COUNT TOTAL		2



Substitution Requests Accepted: Yes

Note: Image(s) may not depict exact product or finishes, see item options.



Sheet Name
Furniture Specifications
Project
FLINT PUBLIC LIBRARY RENOVATION
1026 E. Kearsley St.,
Flint, MI 48503

OPN Project No. **17215000**
Sheet Issue Date **4/28/2021**
Section Number **13.0**
Item Code **TA-17A**

Item Information

Section Number 13.0
Item Code TA-17B
Manufacturer Bernhardt
Model Blueprint Table - Loop Stepped Configuration
- Block Connection Table (seated height)
Model Number BPS-JMB-UBSQA28 WLT 870 WLT 871
Dimensions 108"W. X 42"D. X 30"H.
Description Wood table with stepped configuration - one side at bar height, one side at seated height. Power integration in table top.
Special Instructions Coordinate surface mount power location with designer.

Item Options

Series BPS -
SKU JMB -
Base UB - Block Stepped Connection
Corner SQ - Square
Power A28 - Surface Mount Power Kit -
Black Finish
Base Material WLT - Walnut
Base Finish 870 -
Top Material WLT - Walnut
Top Finish 871

Item Locations/Counts

ROOM NUMBER	ROOM NAME	COUNT
LOWER LEVEL		
132	LOCAL HISTORY & GENEALOGY	2
COUNT TOTAL		2



Substitution Requests Accepted: Yes

Note: Image(s) may not depict exact product or finishes, see item options.



Sheet Name
Furniture Specifications
Project
FLINT PUBLIC LIBRARY RENOVATION
1026 E. Kearsley St.,
Flint, MI 48503

OPN Project No. **17215000**
Sheet Issue Date **4/28/2021**
Section Number **13.0**
Item Code **TA-17B**

Item Information

Section Number 14.0
Item Code LC-3
Manufacturer Coalesse
Model Circa Lounge 60 degree Wedge 2-Seat - Inside
Model Number 451-7460FI
Dimensions --
Description Modular Lounge Seating upholstered in contrasting fabrics.
Special Instructions --

Item Options

Seat Fabric HBF - All Terrain - 11 Alpine
Back Fabric Carnegie - Beam - 12
Shared Wood Leg Type Cylinder Wood Legs -
Wood Color Clear Walnut - V2BW

Item Locations/Counts

ROOM NUMBER	ROOM NAME	COUNT
LOWER LEVEL		
101	STAFF	2
COUNT TOTAL		2



Substitution Requests Accepted: Yes

Note: Image(s) may not depict exact product or finishes, see item options.



Sheet Name
Furniture Specifications
Project
FLINT PUBLIC LIBRARY RENOVATION
1026 E. Kearsley St.,
Flint, MI 48503

OPN Project No. **17215000**
Sheet Issue Date **4/28/2021**
Section Number **14.0**
Item Code **LC-3**

Item Information

Section Number 14.0
Item Code LC-4
Manufacturer Coalesse
Model Circa Lounge 60 degree Wedge 2-Seat -
Outside
Model Number 451-7460FO
Dimensions --
Description Modular Lounge Seating upholstered in contrasting fabrics.
Special Instructions --

Item Options

Seat Fabric HBF - All Terrain - 11 Alpine
Back Fabric Carnegie - Beam - 12
Shared Wood Leg Type Cylinder Wood Legs -
Wood Color Clear Walnut - V2BW

Item Locations/Counts

ROOM NUMBER	ROOM NAME	COUNT
LOWER LEVEL		
101	STAFF	1
COUNT TOTAL		1



Substitution Requests Accepted: Yes

Note: Image(s) may not depict exact product or finishes, see item options.



Sheet Name
Furniture Specifications
Project
FLINT PUBLIC LIBRARY RENOVATION
1026 E. Kearsley St.,
Flint, MI 48503

OPN Project No. **17215000**
Sheet Issue Date **4/28/2021**
Section Number **14.0**
Item Code **LC-4**

Item Information

Section Number 14.0
Item Code LC-21
Manufacturer Coalesse
Model Joel Lounge Chair
Model Number COWK100
Dimensions --
Description Upholstered lounge chair with contrasting fabric and swivel base.
Special Instructions --

Item Options

Seat Fabric (A) Maharam - Scuba - 022 Coral
Back Fabric (B) Maharam - Mister - 005 Notice
Self Return Yes -

Item Locations/Counts

ROOM NUMBER	ROOM NAME	COUNT
MAIN LEVEL		
221	MEETING ROOM	4
COUNT TOTAL		4

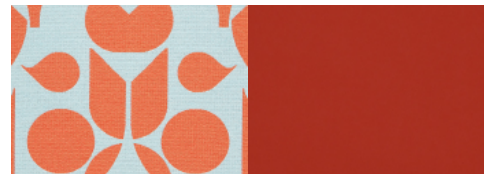

Substitution Requests Accepted: Yes

Note: Image(s) may not depict exact product or finishes, see item options.



Sheet Name
Furniture Specifications
Project
FLINT PUBLIC LIBRARY RENOVATION
1026 E. Kearsley St.,
Flint, MI 48503

OPN Project No. **17215000**
Sheet Issue Date **4/28/2021**
Section Number **14.0**
Item Code **LC-21**

Item Information

Section Number 15.0
Item Code ST-1
Manufacturer Cumberland
Model Clover Bar Stool - High Back
Model Number 1084.0
Dimensions --
Description Upholstered bar height stool with metal legs.
Special Instructions --

Item Options

Leg Finish Satin Stainless Steel -
Fabric HBF - Landscape Blur - 60 Woodland

Item Locations/Counts

ROOM NUMBER	ROOM NAME	COUNT
LOWER LEVEL		
132	LOCAL HISTORY & GENEALOGY	8
COUNT TOTAL		8

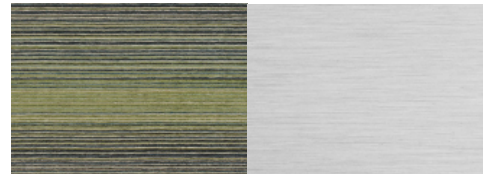

Substitution Requests Accepted: Yes

Note: Image(s) may not depict exact product or finishes, see item options.



Sheet Name
Furniture Specifications
Project
FLINT PUBLIC LIBRARY RENOVATION
1026 E. Kearsley St.,
Flint, MI 48503

OPN Project No. **17215000**
Sheet Issue Date **4/28/2021**
Section Number **15.0**
Item Code **ST-1**

Item Information

Section Number 15.0
Item Code ST-2
Manufacturer Cumberland
Model Clover Counter Stool - High Back
Model Number 1083.0
Dimensions --
Description Upholstered counter height stool with metal legs.
Special Instructions --

Item Options

Leg Finish Satin Stainless Steel -
Fabric Wolf Gordon - Tallinn - Nightfall

Item Locations/Counts

ROOM NUMBER	ROOM NAME	COUNT
MAIN LEVEL		
202	ADULT - FICTION	12
UPPER LEVEL		
305	CAFE	6
327	READING ROOM	6
COUNT TOTAL		24

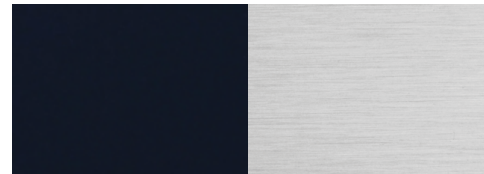

Substitution Requests Accepted: Yes

Note: Image(s) may not depict exact product or finishes, see item options.



Sheet Name
Furniture Specifications
Project
FLINT PUBLIC LIBRARY RENOVATION
1026 E. Kearsley St.,
Flint, MI 48503

OPN Project No. **17215000**
Sheet Issue Date **4/28/2021**
Section Number **15.0**
Item Code **ST-2**

Item Information

Section Number 15.0
Item Code ST-6
Manufacturer Cumberland
Model Clover Counter Stool - High Back
Model Number 1084.0
Dimensions --
Description Upholstered counter height stool with metal legs.
Special Instructions --

Item Options

Leg Finish Satin Stainless Steel -
Fabric HBF - Landscape Blur - 60 Woodland

Item Locations/Counts

ROOM NUMBER	ROOM NAME	COUNT
MAIN LEVEL		
202	ADULT - FICTION	6
COUNT TOTAL		6



Substitution Requests Accepted: Yes

Note: Image(s) may not depict exact product or finishes, see item options.



Sheet Name
Furniture Specifications
Project
FLINT PUBLIC LIBRARY RENOVATION
1026 E. Kearsley St.,
Flint, MI 48503

OPN Project No. **17215000**
Sheet Issue Date **4/28/2021**
Section Number **15.0**
Item Code **ST-6**

Item Information

Section Number 16.0
Item Code LC-5
Manufacturer Davis
Model Q6 Lounge - 120° Shaped Freestanding Bench
Model Number Q6-120
Dimensions --
Description Upholstered bench with back. Contrasting fabrics on seat and back.
Special Instructions --

Item Options

Back Fabric Knoll Textiles - Stripmania Rhubarb
Seat Fabric Wolf Gordon - East Village Grape

Item Locations/Counts

ROOM NUMBER	ROOM NAME	COUNT
MAIN LEVEL		
209	YOUNG ADULT	4
COUNT TOTAL		4

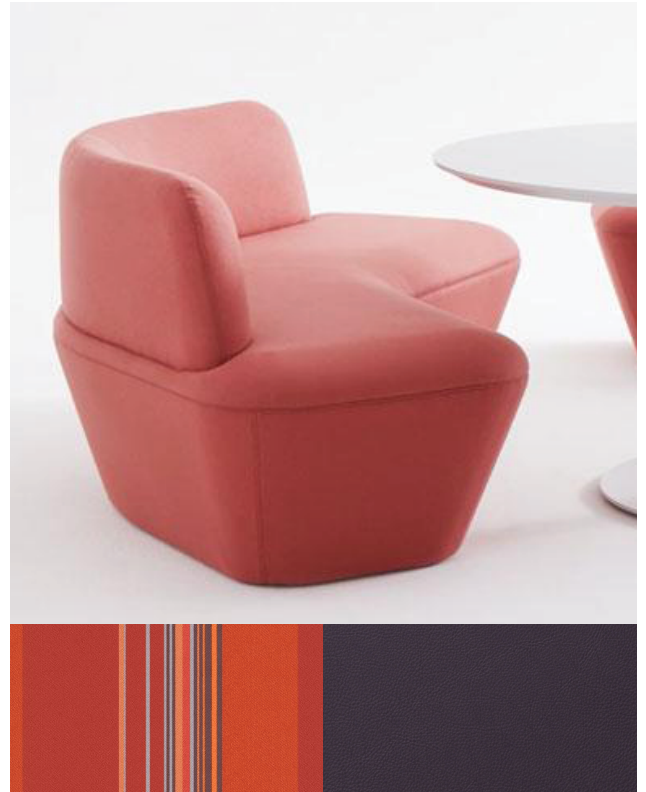

Substitution Requests Accepted: Yes

Note: Image(s) may not depict exact product or finishes, see item options.



Sheet Name
Furniture Specifications
Project
FLINT PUBLIC LIBRARY RENOVATION
1026 E. Kearsley St.,
Flint, MI 48503

OPN Project No. **17215000**
Sheet Issue Date **4/28/2021**
Section Number **16.0**
Item Code **LC-5**

Item Information

Section Number 16.0
Item Code TA-18
Manufacturer Davis
Model Tix Conference Table
Model Number TIX-8520
Dimensions 204 3/4"W. X 48"D. X 29 1/4"H.
Description Double conference table with solid wood top and power integration.
Special Instructions Coordinate surface mount power location with designer.

Item Options

Wood Finish WW - Walnut
Power Accessories TIX-8520-CDH - Cable Duct - horizontal
Power Accessories TIX-8100-CDV - Cable Duct - vertical
Power Accessories TIX-8100-PB - Plug Box
Quantity of Plug Boxes 2 -

Item Locations/Counts

ROOM NUMBER	ROOM NAME	COUNT
UPPER LEVEL		
304	CONFERENCE ROOM	1
COUNT TOTAL		1



Substitution Requests Accepted: Yes

Note: Image(s) may not depict exact product or finishes, see item options.



Sheet Name
Furniture Specifications
Project
FLINT PUBLIC LIBRARY RENOVATION
1026 E. Kearsley St.,
Flint, MI 48503

OPN Project No. **17215000**
Sheet Issue Date **4/28/2021**
Section Number **16.0**
Item Code **TA-18**

Item Information

Section Number 17.0
Item Code LC-6
Manufacturer Fritz Hansen
Model Swan Chair
Model Number 3320.0
Dimensions --
Description Upholstered lounge chair with automatic return.
Special Instructions --

Item Options

Fabric Kvadrat - Divina MD - 683.0
Automatic Return Yes

Item Locations/Counts

ROOM NUMBER	ROOM NAME	COUNT
LOWER LEVEL		
209	YOUNG ADULT	4
COUNT TOTAL		4



Substitution Requests Accepted: Yes

Note: Image(s) may not depict exact product or finishes, see item options.

Item Information

Section Number 18.0
Item Code LC-7
Manufacturer HBF
Model Perfect Pitch Lounge Chair
Model Number HLL209-011
Dimensions --
Description Upholstered lounge chair with wood legs.
Special Instructions --

Item Options

Fabric HBF - Sable Island - 25 Mustang
Wood Finish Ash - AH937 - Bark

Item Locations/Counts

ROOM NUMBER	ROOM NAME	COUNT
MAIN LEVEL		
202	ADULT - FICTION	4
COUNT TOTAL		4



AH937
Bark

Substitution Requests Accepted: Yes

Note: Image(s) may not depict exact product or finishes, see item options.



Sheet Name
Furniture Specifications
Project
FLINT PUBLIC LIBRARY RENOVATION
1026 E. Kearsley St.,
Flint, MI 48503

OPN Project No. **17215000**
Sheet Issue Date **4/28/2021**
Section Number **18.0**
Item Code **LC-7**

Item Information

Section Number 18.0
Item Code LC-8
Manufacturer HBF
Model Scoop Lounge Chair
Model Number HLP402-021
Dimensions --
Description Upholstered lounge chair.
Special Instructions --

Item Options

Fabric HBF Abito - Garda
Base Style PW - Plinth Wood

Item Locations/Counts

ROOM NUMBER	ROOM NAME	COUNT
MAIN LEVEL		
202	ADULT - FICTION	8
UPPER LEVEL		
302	ADULT - NON FICTION	6
COUNT TOTAL		14



Substitution Requests Accepted: Yes

Note: Image(s) may not depict exact product or finishes, see item options.



Sheet Name
Furniture Specifications
Project
FLINT PUBLIC LIBRARY RENOVATION
1026 E. Kearsley St.,
Flint, MI 48503

OPN Project No. **17215000**
Sheet Issue Date **4/28/2021**
Section Number **18.0**
Item Code **LC-8**

Item Information

Section Number 18.0
Item Code LC-9
Manufacturer HBF
Model Perfect Pitch Lounge Chair
Model Number HLL209-011
Dimensions --
Description Upholstered lounge chair with wood legs.
Special Instructions *40% overage required due to repeat.*
* Provide Nanotex + moisture barrier backing*

Item Options

Fabric Luum - Second Nature - Muscadine
Wood Finish Ash - AH937 - Bark

Item Locations/Counts

ROOM NUMBER	ROOM NAME	COUNT
UPPER LEVEL		
303	UNCONFERENCE ROOM	4
COUNT TOTAL		4

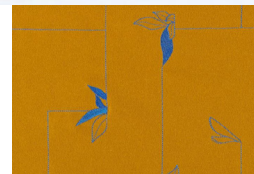

AH937
Bark

Substitution Requests Accepted: Yes

Note: Image(s) may not depict exact product or finishes, see item options.

Item Information

Section Number 19.0
Item Code CH-13
Manufacturer Herman Miller
Model Setu Chair
Model Number CQ5
Dimensions --
Description Multipurpose side chair with casters and fixed arms.
Special Instructions --

Item Options

Base Type/Height 1 - 5-star base, standard-height range
Adjustment
Seat/Back Material M - Lyris 2 Suspension seat and back
Arms A - Ribbon Arms
Frame Finish G1 - Graphite
Base Finish 5Y - Semi-polished
Casters/Glides HCC - 2 1/2" low roll resistance, black
Bumper NNN - None
Suspension Material 4W31 - Graphite

Item Locations/Counts

ROOM NUMBER	ROOM NAME	COUNT
LOWER LEVEL		
103	OFFICE	3
104	OFFICE	2
106	OFFICE	3
107	OFFICE	2
108	OFFICE	2
109	OFFICE	2
110	OFFICE	2
112A	OFFICE	2
136	OFFICE	1
139	OFFICE	1
COUNT TOTAL		20

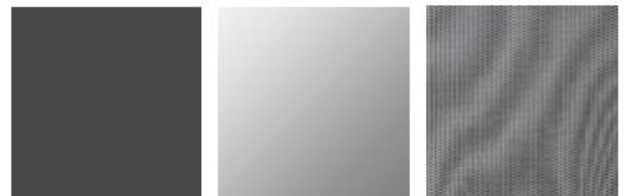

Substitution Requests Accepted: Yes

Note: Image(s) may not depict exact product or finishes, see item options.

Item Information

Section Number 19.0
Item Code CH-14
Manufacturer Herman Miller
Model Polly Side Chair
Model Number NOPLN
Dimensions 20"W. X 21"D. X 31"H. (17.5" Seat Height)
Description Café chair with polypropelene seat and metal legs.
Special Instructions --

Item Options

Base/Arm Type 100 - 4-Leg - No arms
Seat Pad NP - No Seat Pad
Base Finish R13 - Pastel blue RAL 5024
Shell Finish R13 - Pastel blue RAL 5024
Glide Options FG - Felt Glides

Item Locations/Counts

ROOM NUMBER	ROOM NAME	COUNT
LOWER LEVEL		
116	BREAK ROOM	8
COUNT TOTAL		8



PastelBlue
RAL 5024

Substitution Requests Accepted: Yes

Note: Image(s) may not depict exact product or finishes, see item options.

Item Information

Section Number 19.0
Item Code CH-15
Manufacturer Herman Miller
Model Caper Chair - White
Model Number WC4-20-N
Dimensions --
Description Armless multipurpose chair with casters, flexnet seat, silver frame, and white plastic back.
Special Instructions --

Item Options

Seat Style 20 - Flexnet Seat
Arms N - No Arms
Frame Finish MS - Metallic Silver
Seat/Back Finish 98 - Studio White
Casters/Glides U5 - Soft wheel, carpet or hard floors
Flexnet Material 6V02 - Silver Grey

Item Locations/Counts

ROOM NUMBER	ROOM NAME	COUNT
MAIN LEVEL		
234	COMMUNITY ROOM	44
UPPER LEVEL		
308	DIGITAL MEDIA LAB	8
309	DIGITAL MEDIA/ MAKER LAB	6
311	STORAGE	2
314	MEETING ROOM	5
326	MEETING ROOM	11
COUNT TOTAL		76



Substitution Requests Accepted: Yes

Note: Image(s) may not depict exact product or finishes, see item options.

Item Information

Section Number 19.0
 Item Code CH-16
 Manufacturer Herman Miller
 Model Caper Chair - Silver
 Model Number WC4-20-N
 Dimensions --
 Description Armless multipurpose chair with casters, flexnet seat, silver frame, and grey plastic back.
 Special Instructions --

Item Options

Seat Style 20 - Flexnet Seat
 Arms N - No Arms
 Frame Finish MS - Metallic Silver
 Seat/Back Finish 63 - Fog
 Casters/Glides U5 - Soft wheel, carpet or hard floors
 Flexnet Material 6V02 - Silver Grey

Item Locations/Counts

ROOM NUMBER	ROOM NAME	COUNT
MAIN LEVEL		
234	COMMUNITY ROOM	44
UPPER LEVEL		
308	DIGITAL MEDIA LAB	8
309	DIGITAL MEDIA/ MAKER LAB	6
311	STORAGE	2
314	MEETING ROOM	6
326	MEETING ROOM	11
COUNT TOTAL		77



Substitution Requests Accepted: Yes

Note: Image(s) may not depict exact product or finishes, see item options.

Item Information

Section Number 19.0
Item Code CH-17
Manufacturer Herman Miller
Model Caper Chair - Teal
Model Number WC4-20-N
Dimensions --
Description Armless multipurpose chair with casters, flexnet seat, silver frame, and turquoise plastic back.
Special Instructions --

Item Options

Seat Style 20 - Flexnet Seat
Arms N - No Arms
Frame Finish MS - Metallic Silver
Seat/Back Finish TRQ - Turquoise
Casters/Glides U5 - Soft wheel, carpet or hard floors
Flexnet Material 6V02 - Silver Grey

Item Locations/Counts

ROOM NUMBER	ROOM NAME	COUNT
MAIN LEVEL		
234	COMMUNITY ROOM	44
UPPER LEVEL		
308	DIGITAL MEDIA LAB	8
309	DIGITAL MEDIA/ MAKER LAB	6
311	STORAGE	2
314	MEETING ROOM	5
326	MEETING ROOM	10
COUNT TOTAL		75



Substitution Requests Accepted: Yes

Note: Image(s) may not depict exact product or finishes, see item options.

Item Information

Section Number 19.0
 Item Code CH-18
 Manufacturer Herman Miller
 Model Caper Chair - Black
 Model Number WC4-20-N
 Dimensions --
 Description Armless multipurpose chair with casters, flexnet seat, black frame, and black plastic back.
 Special Instructions --

Item Options

Seat Style 20 - Flexnet Seat
 Arms N - No Arms
 Frame Finish BK - Black
 Seat/Back Finish BK - Black
 Casters/Glides U5 - Soft wheel, carpet or hard floors
 Flexnet Material 6V01 - Black

Item Locations/Counts

ROOM NUMBER	ROOM NAME	COUNT
LOWER LEVEL		
132	LOCAL HISTORY & GENEALOGY	5
MAIN LEVEL		
204	STUDY ROOM	4
205	STUDY ROOM	4
206	STUDY ROOM	4
207	STUDY ROOM	4
UPPER LEVEL		
306	PUBLIC ACCESS COMPUTERS	22
313	MEETING ROOM	4
328	STUDY ROOM	4
329	STUDY ROOM	4
330	STUDY ROOM	4
COUNT TOTAL		59



Black
BK

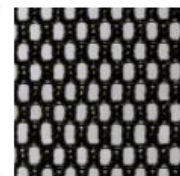

Black
6V01

Substitution Requests Accepted: Yes

Note: Image(s) may not depict exact product or finishes, see item options.

Item Information

Section Number 19.0
 Item Code CH-18A
 Manufacturer Herman Miller
 Model Caper Chair - Black
 Model Number WC4-20-P
 Dimensions --
 Description Multipurpose chair with arms, casters, flexnet seat, black frame, and black plastic back.
 Special Instructions --

Item Options

Seat Style 20 - Flexnet Seat
 Arms P - Fixed Arms
 Frame Finish BK - Black
 Seat/Back Finish BK - Black
 Casters/Glides U5 - Soft wheel, carpet or hard floors
 Arm Finish BK - Black
 Flexnet Material 6V01 - Black

Item Locations/Counts

ROOM NUMBER	ROOM NAME	COUNT
LOWER LEVEL		
132	LOCAL HISTORY & GENEALOGY	14
133	GENEALOGY VAULT	1
134	SPECIAL COLLECTIONS	4
UPPER LEVEL		
306	PUBLIC ACCESS COMPUTERS	8
313	MEETING ROOM	2
328	STUDY ROOM	2
329	STUDY ROOM	2
330	STUDY ROOM	2
COUNT TOTAL		35

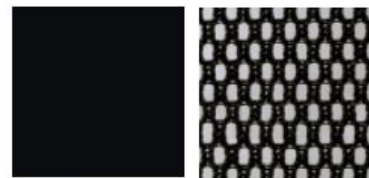

Black
BK

Black
6V01

Substitution Requests Accepted: Yes

Note: Image(s) may not depict exact product or finishes, see item options.

Item Information

Section Number 19.0
Item Code LC-10
Manufacturer Herman Miller
Model Saiba Lounge Chair
Model Number SBN5H
Dimensions --
Description Upholstered lounge chair with metal swivel base.
Special Instructions --

Item Options

Fabric Geiger Textiles - Antico - 1GM04 Desert
Base Finish CD - Polished Aluminum

Item Locations/Counts

ROOM NUMBER	ROOM NAME	COUNT
LOWER LEVEL		
102	PROJECT ROOM	6
MAIN LEVEL		
203	STUDY ROOM	4
208	STUDY ROOM	4
COUNT TOTAL		14

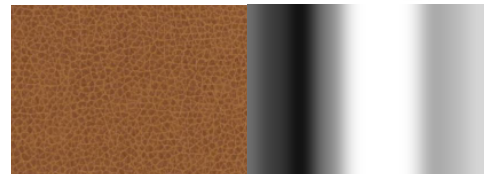

Substitution Requests Accepted: Yes

Note: Image(s) may not depict exact product or finishes, see item options.

Item Information

Section Number 19.0
 Item Code ST-4
 Manufacturer Herman Miller
 Model Aeron Work Stool
 Model Number AER7-1
 Dimensions Seat Height Range: 24.75" - 29.25"
 Description Low height work stool.
 Special Instructions --

Item Options

Height 1 - Low
 Tilt 2 - Tilt Limiter
 Arms H - Height-adjustable Arms
 Armpad Upholstery W - Nonupholstered Armpads
 Back Support Option ALP - Adjustable Posturefit SL
 Frame/Foot Ring Tread G1 - Graphite
 Chassis & Foot Ring CD - Polished Aluminum
 Base Finish CD - Polished Aluminum
 Casters/Glides C7 - 2 1/2", black, hard floors or carpet
 Armpad Finish BK - Black
 8Z Pellicle 23103 - Graphite

Item Locations/Counts

ROOM NUMBER	ROOM NAME	COUNT
LOWER LEVEL		
132	LOCAL HISTORY & GENEALOGY	2
MAIN LEVEL		
202	ADULT - FICTION	4
212	CHILDREN'S COLLECTION	2
UPPER LEVEL		
302	ADULT - NON FICTION	1
306	PUBLIC ACCESS COMPUTERS	1
COUNT TOTAL		10

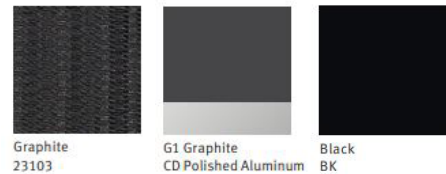

Substitution Requests Accepted: Yes

Note: Image(s) may not depict exact product or finishes, see item options.



Sheet Name
Furniture Specifications
 Project
FLINT PUBLIC LIBRARY RENOVATION
 1026 E. Kearsley St.,
 Flint, MI 48503

OPN Project No. **17215000**
 Sheet Issue Date **4/28/2021**
 Section Number **19.0**
 Item Code **ST-4**

Item Information

Section Number 19.0
Item Code ST-5
Manufacturer Herman Miller
Model Polly Counter Stool
Model Number NOPLN
Dimensions Seat Height: 25.5"
Description Counter stool with polypropelene seat and metal legs.
Special Instructions --

Item Options

Base/Arm Type 500 - 4-Leg Counter height stool - no arms
Seat Pad NP - No seat pad
Base Finish R13 - Pastel blue RAL 5024
Shell Finish R13 - Pastel blue RAL 5024
Glide Options FG - Felt Glides

Item Locations/Counts

ROOM NUMBER	ROOM NAME	COUNT
LOWER LEVEL		
116	BREAK ROOM	4
COUNT TOTAL		4



PastelBlue
RAL 5024

Substitution Requests Accepted: Yes

Note: Image(s) may not depict exact product or finishes, see item options.

Item Information

Section Number 19.0
Item Code TA-14
Manufacturer Herman Miller
Model Eames Contract Base, T-leg Table, Rectangular
Model Number ET-1-T-L
Dimensions 42"W. X 24"D. X 28.5"H.
Description Seated height café table with laminate top and vinyl edge.
Special Instructions --

Item Options

Height 1 - 28.5" high
Depth/Width 21R - 24" deep X 42" wide
Base T - Contract base, T-leg
Surface Material L - Laminate top with vinyl edge
Grommets NG - No grommet
Top Finish 98 - Studio White
Edge Finish 98 - Studio White
Column Finish 91 - White
Base Finish PA - Polished aluminum
Casters/Glides G - Glides

Item Locations/Counts

ROOM NUMBER	ROOM NAME	COUNT
MAIN LEVEL		
220	SNACK AREA	2
COUNT TOTAL		2



Substitution Requests Accepted: Yes

Note: Image(s) may not depict exact product or finishes, see item options.

Item Information

Section Number 7.0
Item Code TA-15
Manufacturer 3Branch
Model Skware Table
Model Number SK-4284
Dimensions 42"D. x 84"W. x 29.5"H.
Description Seated height table with quartz top.
Special Instructions --

Item Options

Top Finish Corian Quartz - Nebula
Base Finish Brushed Stainless Steel

Item Locations/Counts

ROOM NUMBER	ROOM NAME	COUNT
LOWER LEVEL		
133	GENEALOGY VAULT	1
134	SPECIAL COLLECTIONS	1
COUNT TOTAL		2



Substitution Requests Accepted: Yes

Note: Image(s) may not depict exact product or finishes, see item options.



Sheet Name
Furniture Specifications
Project
FLINT PUBLIC LIBRARY RENOVATION
1026 E. Kearsley St.,
Flint, MI 48503

OPN Project No. **17215000**
Sheet Issue Date **4/28/2021**
Section Number **7.0**
Item Code **TA-15**

Item Information

Section Number 19.0
 Item Code TA-20a
 Manufacturer Herman Miller
 Model Canvas Team Wall - Technology Module
 Model Number FC100
 Dimensions 48" W. X 20"D. X 68"H.
 Description Freestanding wall with removable bottom door. Peninsula table attachment. 6 outlet power strip in base.
 Special Instructions --

Item Options

Height 68 - 68" High
 Width 48 - 48" Wide
 Technology Display SP - Seated-height display, for use with peninsula
 Height
 Case Material L - Laminate
 Shelf/Technology Door L - Laminate
 Material
 Power P - Power strip
 Case Finish LBU - Medium matte walnut
 Shelf Finish 98 - Studio white

Item Locations/Counts

ROOM NUMBER	ROOM NAME	COUNT
306	PUBLIC ACCESS COMPUTERS	2
COUNT TOTAL		2

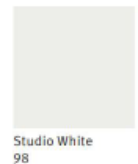

Studio White
98



Medium Matte Walnut
LBU

Substitution Requests Accepted: Yes

Note: Image(s) may not depict exact product or finishes, see item options.



Sheet Name
Furniture Specifications
 Project
FLINT PUBLIC LIBRARY RENOVATION
 1026 E. Kearsley St.,
 Flint, MI 48503

OPN Project No. **17215000**
 Sheet Issue Date **4/28/2021**
 Section Number **19.0**
 Item Code **TA-20a**

Item Information

Section Number 19.0
Item Code TA-20b
Manufacturer Herman Miller
Model Canvas Peninsula Surface, Team Wall
Model Number FCT35
Dimensions 78"W. X 48"D.
Description Peninsula table top.
Special Instructions --

Item Options

Edge T35 - Thin-edge
Depth 46 - 46" deep
Width 60 - 60" wide
Surface Material L - Laminate top/thermoplastic edge
Top/Edge Finish 98 - Studio white

Item Locations/Counts

ROOM NUMBER	ROOM NAME	COUNT
306	PUBLIC ACCESS COMPUTERS	2
COUNT TOTAL		2

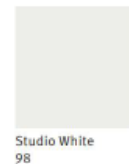
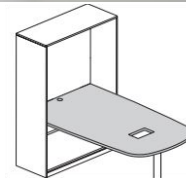

Substitution Requests Accepted: Yes

Note: Image(s) may not depict exact product or finishes, see item options.



Sheet Name
Furniture Specifications
Project
FLINT PUBLIC LIBRARY RENOVATION
1026 E. Kearsley St.,
Flint, MI 48503

OPN Project No. **17215000**
Sheet Issue Date **4/28/2021**
Section Number **19.0**
Item Code **TA-20b**

Item Information

Section Number 19.0
Item Code TA-20c
Manufacturer Herman Miller
Model Column Kit, Group Peninsula Surface
Model Number FC235
Dimensions --
Description Column kit that attached to and supports the end of the peninsula surface. Includes 10' power cord with 3 prong plug end.
Special Instructions --

Item Options

Application S - Seated Height
Power/Data Access A - Modular power cord w/ plug end
Surface Width 60 - 60" wide
Grommet Finish 98 - Studio white
Column/Bin Finish 98 - Studio white

Item Locations/Counts

ROOM NUMBER	ROOM NAME	COUNT
306	PUBLIC ACCESS COMPUTERS	2
COUNT TOTAL		2

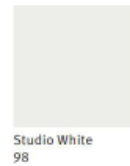

Substitution Requests Accepted: Yes

Note: Image(s) may not depict exact product or finishes, see item options.



Sheet Name
Furniture Specifications
Project
FLINT PUBLIC LIBRARY RENOVATION
1026 E. Kearsley St.,
Flint, MI 48503

OPN Project No. **17215000**
Sheet Issue Date **4/28/2021**
Section Number **19.0**
Item Code **TA-20c**

Item Information

Section Number 19.0
Item Code TA-22
Manufacturer Herman Miller
Model Everywhere Flip Top Table
Model Number DT5A
Dimensions 72"W. X 30"D. X 28.5"H.
Description Flip top table with chrome base and formcoat top.
Special Instructions --

Item Options

Edge T - Thin-edge
Depth 30 - 30" Deep
Width 72 - 72" Wide
Surface Material P - Painted Formcoat Top/Edge
Leg Type T - T-leg
Top/Edge Finish 8Q - Folkstone Grey
Leg Finish CD - Polished Aluminum
Casters/Glides 20 - Casters

Item Locations/Counts

ROOM NUMBER	ROOM NAME	COUNT
MAIN LEVEL		
234	COMMUNITY ROOM	32
UPPER LEVEL		
314	MEETING ROOM	8
326	MEETING ROOM	16
COUNT TOTAL		56



Substitution Requests Accepted: Yes

Note: Image(s) may not depict exact product or finishes, see item options.



Sheet Name
Furniture Specifications
Project
FLINT PUBLIC LIBRARY RENOVATION
1026 E. Kearsley St.,
Flint, MI 48503

OPN Project No. **17215000**
Sheet Issue Date **4/28/2021**
Section Number **19.0**
Item Code **TA-22**

Item Information

Section Number 19.0
Item Code TA-29
Manufacturer Herman Miller
Model Everywhere Round Table
Model Number DT1CT
Dimensions 36"Dia. X 28.5"H
Description Round seated height table.
Special Instructions --

Item Options

Edge T - Thin-edge
Diameter 36 - 36" Diameter
Surface Material P - Painted Formcoat top/edge
Leg/Base Type X - 4-column base
Top/Edge Finish 91 - White
Leg/Base Finish MS - Metallic Silver
Casters/Glides 57 - Glides

Item Locations/Counts

ROOM NUMBER	ROOM NAME	COUNT
LOWER LEVEL		
103	OFFICE	1
106	OFFICE	1
COUNT TOTAL		2



Substitution Requests Accepted: Yes

Note: Image(s) may not depict exact product or finishes, see item options.



Sheet Name
Furniture Specifications
Project
FLINT PUBLIC LIBRARY RENOVATION
1026 E. Kearsley St.,
Flint, MI 48503

OPN Project No. **17215000**
Sheet Issue Date **4/28/2021**
Section Number **19.0**
Item Code **TA-29**

Item Information

Section Number 19.0
Item Code TA-30
Manufacturer Herman Miller
Model Everywhere Square Table
Model Number DT1BT
Dimensions 42"W X 42"D X 28.5"H
Description Square seated height table.
Special Instructions --

Item Options

Edge T - Thin-edge
Depth/Width 4242 - 42" deep x 42" wide
Surface Material P - Painted formcoat top/edge
Leg/Base Type P - Post Leg
Top/Edge Finish 91 - White
Leg Finish MS - Metallic Silver
Casters/Glides 57 - Glides

Item Locations/Counts

ROOM NUMBER	ROOM NAME	COUNT
LOWER LEVEL		
112B	SECURED STORAGE	1
113	STORAGE	1
COUNT TOTAL		2



Substitution Requests Accepted: Yes

Note: Image(s) may not depict exact product or finishes, see item options.



Sheet Name
Furniture Specifications
Project
FLINT PUBLIC LIBRARY RENOVATION
1026 E. Kearsley St.,
Flint, MI 48503

OPN Project No. **17215000**
Sheet Issue Date **4/28/2021**
Section Number **19.0**
Item Code **TA-30**

Item Information

Section Number 19.0
Item Code EAP-1
Manufacturer Herman Miller
Model Prospect Exterior Acoustic Pad
Model Number CBEAP-SC
Dimensions --
Description Upholstered acoustic pad on exterior of workstation.
Special Instructions --

Item Options

Type SC - Solo Structure
Height 54 - 54" High
Acoustic Pad Type UP - Upholstered
Acoustic Pad Cover 1HA12 - Medley - Peacock

Item Locations/Counts

ROOM NUMBER	ROOM NAME	COUNT
LOWER LEVEL		
101	STAFF	16
COUNT TOTAL		16

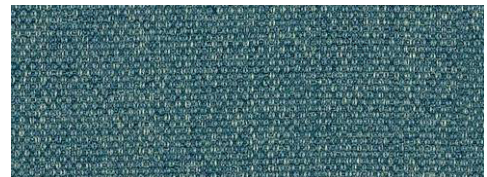
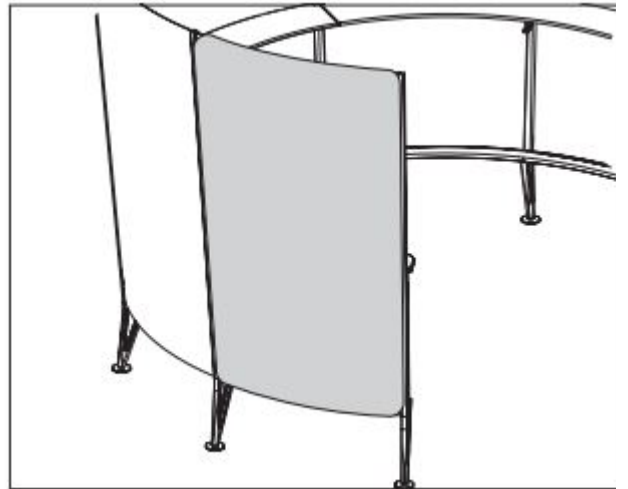

Substitution Requests Accepted: Yes

Note: Image(s) may not depict exact product or finishes, see item options.



Sheet Name
Furniture Specifications
Project
FLINT PUBLIC LIBRARY RENOVATION
1026 E. Kearsley St.,
Flint, MI 48503

OPN Project No. **17215000**
Sheet Issue Date **4/28/2021**
Section Number **19.0**
Item Code **EAP-1**

Item Information

Section Number 19.0
 Item Code PED-1
 Manufacturer Herman Miller
 Model Mobile Pedestal
 Model Number LK11
 Dimensions --
 Description Box/file mobile pedestal
 Special Instructions --

Item Options

Front Material L - Laminate Front
 Depth 20 - 20" Deep
 Configuration BF - Box/file
 Slides SB - Full-extension ball-bearing
 Paint/Steel Type SS - Smooth Paint on Smooth Steel
 Surface Finish 98 - Studio White
 Front Finish 98 - Studio White
 Lock KC - Keyed Differently, Chrome
 Pull Finish MS - Metallic Silver
 Drawer Interior 5M - Pencil tray and file converters
 Handle HN - No Hand Grip

Item Locations/Counts

ROOM NUMBER	ROOM NAME	COUNT
LOWER LEVEL		
101	STAFF	4
125	SHIPPING & RECEIVING	3
135	TECH SERVICES/ LOAN WORK ROOM	4
140	STORAGE	1
COUNT TOTAL		12



Studio White
98

Substitution Requests Accepted: No

Note: Image(s) may not depict exact product or finishes, see item options.



Sheet Name
Furniture Specifications
 Project
FLINT PUBLIC LIBRARY RENOVATION
 1026 E. Kearsley St.,
 Flint, MI 48503

OPN Project No. **17215000**
 Sheet Issue Date **4/28/2021**
 Section Number **19.0**
 Item Code **PED-1**

Item Information

Section Number 19.0
Item Code PED-2
Manufacturer Herman Miller
Model Pedestal Cushion Top
Model Number LG890.1.20
Dimensions --
Description Mobile pedestal cushion top.
Special Instructions --

Item Options

Height 1 - 1" High
Depth 20 - 20" Deep
Fabric Geiger - Striae - 19992 Blue

Item Locations/Counts

ROOM NUMBER	ROOM NAME	COUNT
LOWER LEVEL		
101	STAFF	4
125	SHIPPING & RECEIVING	3
135	TECH SERVICES/ LOAN WORK ROOM	4
140	STORAGE	1
COUNT TOTAL		12

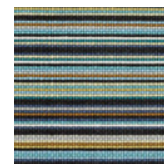

Substitution Requests Accepted: No

Note: Image(s) may not depict exact product or finishes, see item options.



Sheet Name
Furniture Specifications
Project
FLINT PUBLIC LIBRARY RENOVATION
1026 E. Kearsley St.,
Flint, MI 48503

OPN Project No. **17215000**
Sheet Issue Date **4/28/2021**
Section Number **19.0**
Item Code **PED-2**

Item Information

Section Number 19.0
Item Code PO-1
Manufacturer Herman Miller
Model Canvas Private Office
Model Number --
Dimensions --
Description Private Office Type 1
Special Instructions Storage to be keyed alike per workstation.
See grommet locations on enlarged plan.

Item Options

Storage Finish 98 - Studio White
Worksurface Finish 98 - Studio White
Leg Finish MS - Metallic Silver
Tackable Fabric Whisper - Silver Pine
Ped File Cushion Fabric Geiger - Striae - Blue
Accessories Wire Management Tray
Power Strip w/ 10' Cord.

Item Locations/Counts

ROOM NUMBER	ROOM NAME	COUNT
LOWER LEVEL		
111	OFFICE	1
COUNT TOTAL		1

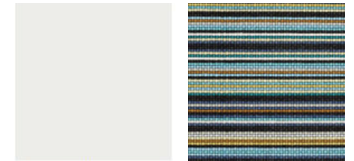

Studio White
98

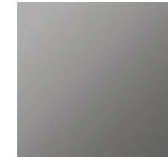

Metallic Silver
MS

Substitution Requests Accepted: No

Note: Image(s) may not depict exact product or finishes, see item options.



Sheet Name
Furniture Specifications
Project
FLINT PUBLIC LIBRARY RENOVATION
1026 E. Kearsley St.,
Flint, MI 48503

OPN Project No. **17215000**
Sheet Issue Date **4/28/2021**
Section Number **19.0**
Item Code **PO-1**

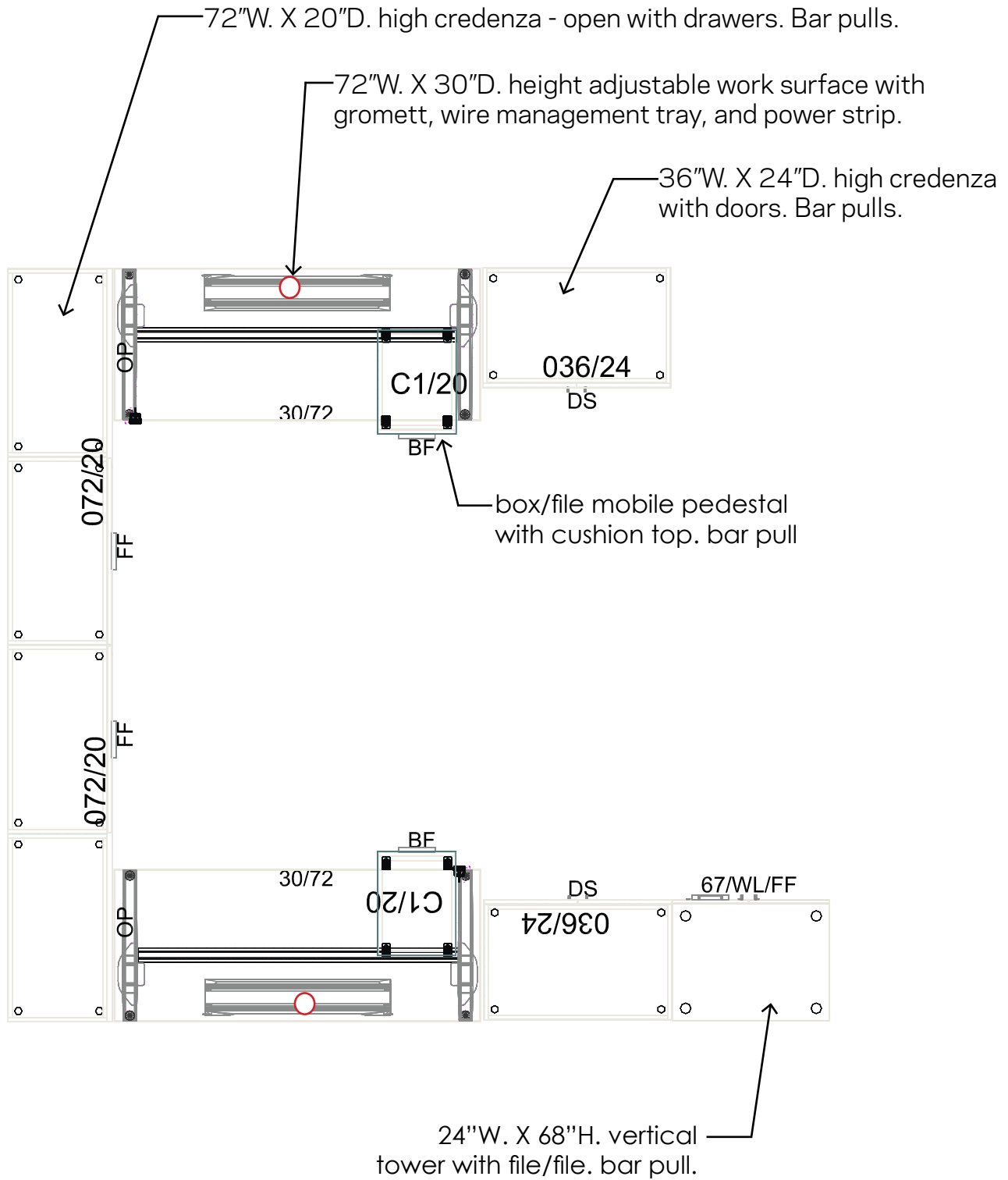

Item Information

Section Number 19.0
 Item Code PO-2
 Manufacturer Herman Miller
 Model Canvas Private Office
 Model Number --
 Dimensions --
 Description Private Office Type 2
 Special Instructions Storage to be keyed alike per workstation.
 See grommet locations on enlarged plan.

Item Options

Storage Finish 98 - Studio White
 Worksurface Finish 98 - Studio White
 Leg Finish MS - Metallic Silver
 Tackable Fabric Whisper - Silver Pine
 Ped File Cushion Fabric Geiger - Striae - Blue
 Accessories Wire Management Tray
 Power Strip w/ 10' Cord

Item Locations/Counts

ROOM NUMBER	ROOM NAME	COUNT
LOWER LEVEL		
107	OFFICE	1
108	OFFICE	1
109	OFFICE	1
110	OFFICE	1
112A	OFFICE	1
COUNT TOTAL		5

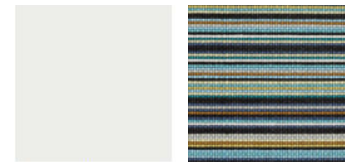

Studio White
98

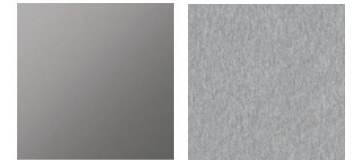

Metallic Silver
MS

Substitution Requests Accepted: No

Note: Image(s) may not depict exact product or finishes, see item options.



Sheet Name
Furniture Specifications
 Project
FLINT PUBLIC LIBRARY RENOVATION
 1026 E. Kearsley St.,
 Flint, MI 48503

OPN Project No. **17215000**
 Sheet Issue Date **4/28/2021**
 Section Number **19.0**
 Item Code **PO-2**

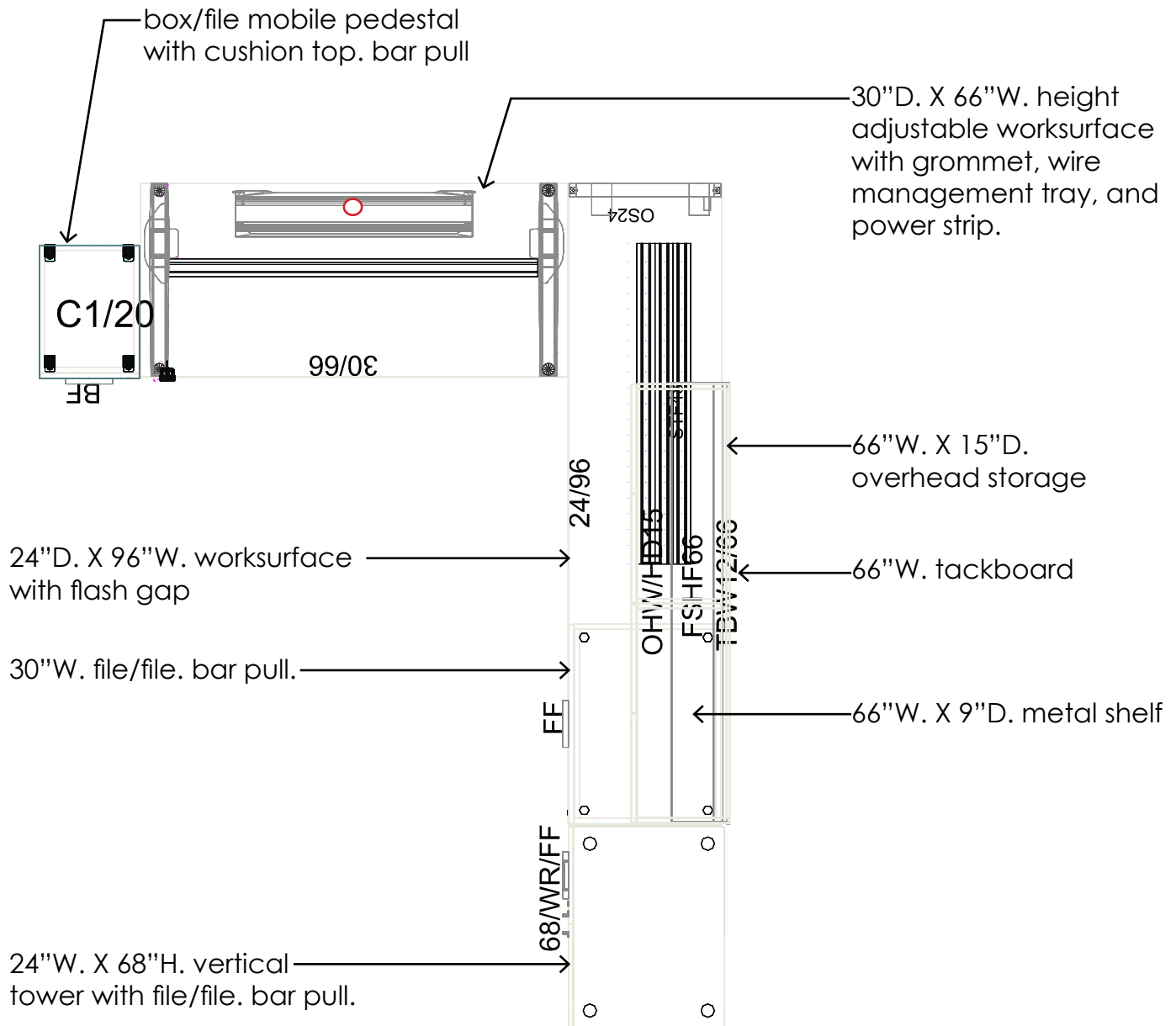

Item Information

Section Number 19.0
 Item Code PO-3
 Manufacturer Herman Miller
 Model Canvas Private Office
 Model Number --
 Dimensions --
 Description Private Office Type 3
 Special Instructions Storage to be keyed alike per workstation.
 See grommet locations on enlarged plan.

Item Options

Storage Finish 98 - Studio White
 Worksurface Finish 98 - Studio White
 Leg Finish MS - Metallic Silver
 Tackable Fabric Whisper - Silver Pine
 Ped File Cushion Fabric Geiger - Striae - Blue
 Accessories Wire Management Tray -
 Power Strip w/ 10' Cord -

Item Locations/Counts

ROOM NUMBER	ROOM NAME	COUNT
LOWER LEVEL		
104	OFFICE	1
COUNT TOTAL		1

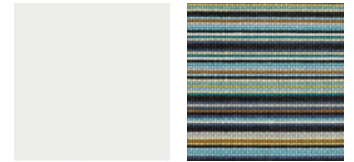

Studio White
98

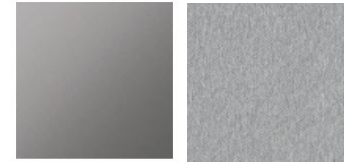

Metallic Silver
MS

Substitution Requests Accepted: No

Note: Image(s) may not depict exact product or finishes, see item options.



Sheet Name
Furniture Specifications
 Project
FLINT PUBLIC LIBRARY RENOVATION
 1026 E. Kearsley St.,
 Flint, MI 48503

OPN Project No. **17215000**
 Sheet Issue Date **4/28/2021**
 Section Number **19.0**
 Item Code **PO-3**

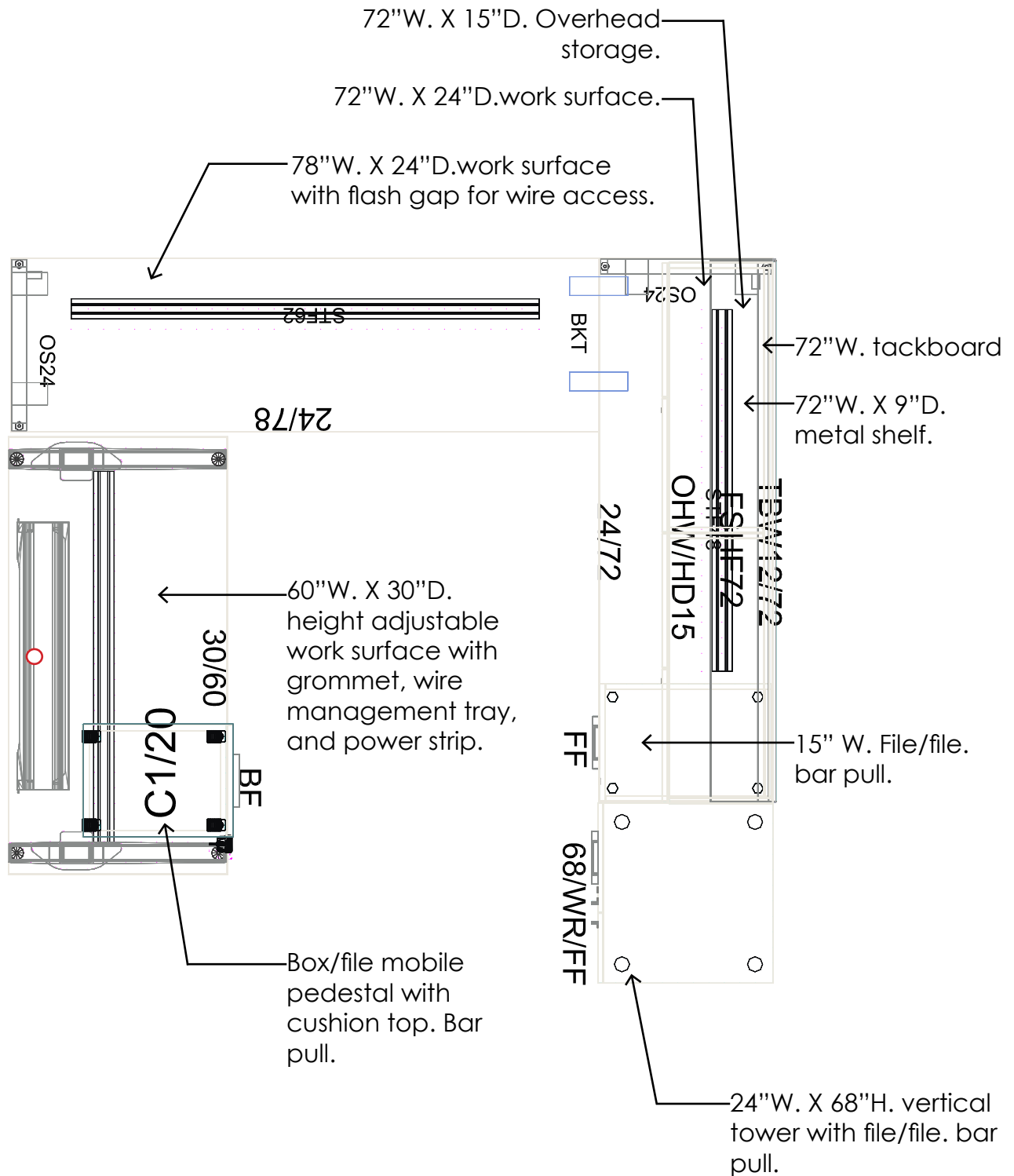

Item Information

Section Number 19.0
 Item Code PO-4
 Manufacturer Herman Miller
 Model Canvas Private Office
 Model Number --
 Dimensions --
 Description Private Office Type 4
 Special Instructions Storage to be keyed alike per workstation.
 See grommet locations on enlarged plan.

Item Options

Storage Finish 98 - Studio White
 Worksurface Finish 98 - Studio White
 Leg Finish MS - Metallic Silver
 Tackable Fabric Whisper - Silver Pine
 Ped File Cushion Fabric Geiger - Striae - Blue
 Accessories Wire Management Tray
 Power Strip w/ 10' Cord

Item Locations/Counts

ROOM NUMBER	ROOM NAME	COUNT
LOWER LEVEL		
103	OFFICE	1
106	OFFICE	1
COUNT TOTAL		2



Studio White
98

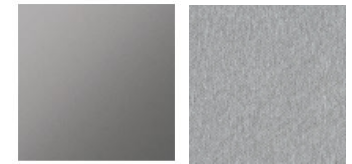

Metallic Silver
MS

Substitution Requests Accepted: No

Note: Image(s) may not depict exact product or finishes, see item options.



Sheet Name
Furniture Specifications
 Project
FLINT PUBLIC LIBRARY RENOVATION
 1026 E. Kearsley St.,
 Flint, MI 48503

OPN Project No. **17215000**
 Sheet Issue Date **4/28/2021**
 Section Number **19.0**
 Item Code **PO-4**

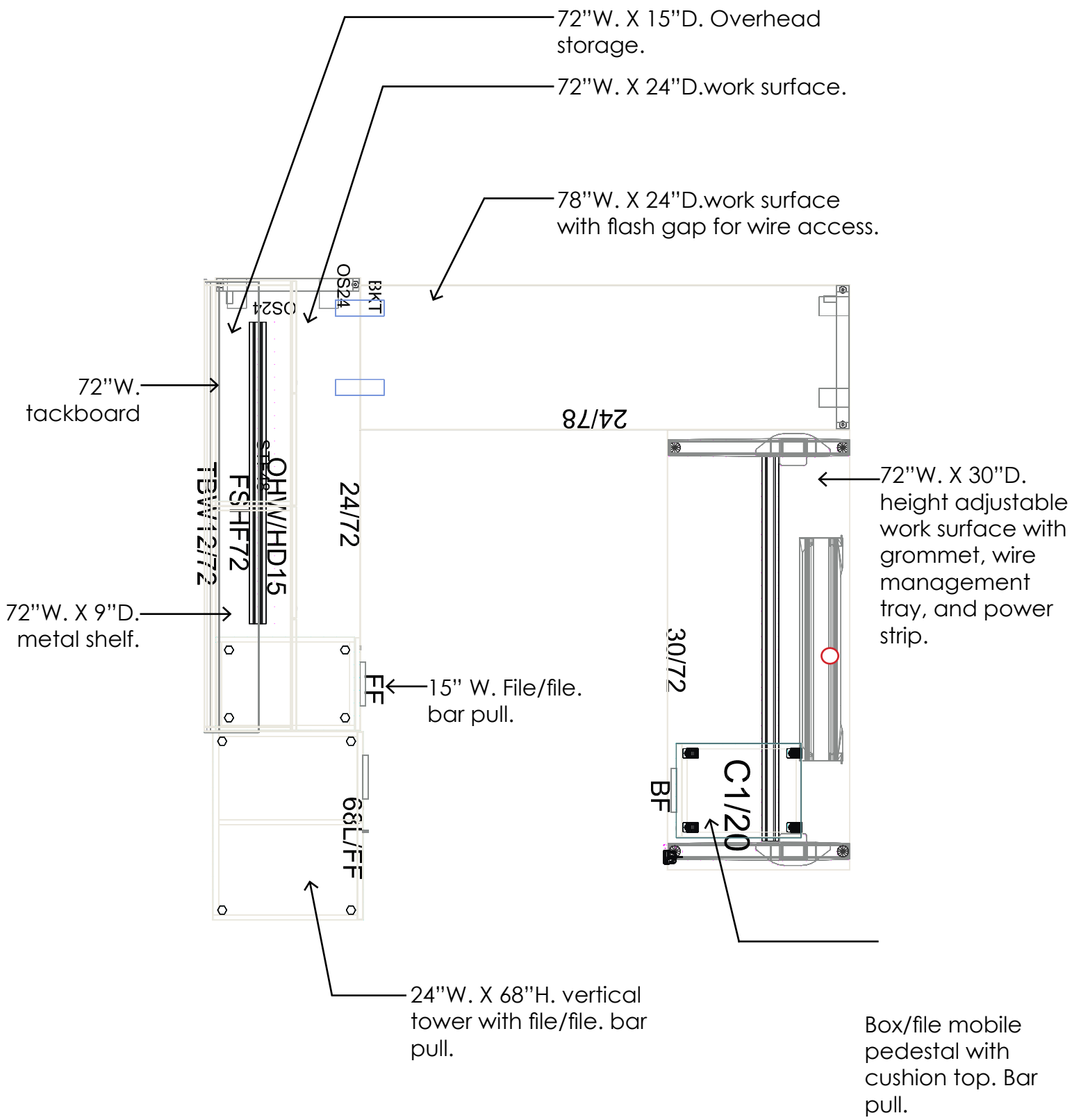

Item Information

Section Number 19.0
Item Code PO-5
Manufacturer Herman Miller
Model Canvas Private Office
Model Number --
Dimensions --
Description Private Office Type 5
Special Instructions Storage to be keyed alike per workstation.
See grommet locations on enlarged plan.

Item Options

Storage Finish 98 - Studio White
Worksurface Finish 98 - Studio White
Leg Finish MS - Metallic Silver
Tackable Fabric Whisper - Silver Pine
Ped File Cushion Fabric Geiger - Striae - Blue
Accessories Wire Management Tray

Item Locations/Counts

ROOM NUMBER	ROOM NAME	COUNT
LOWER LEVEL		
136	OFFICE	1
COUNT TOTAL		1

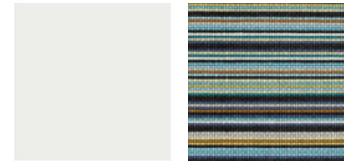

Studio White
98



Metallic Silver
MS

Substitution Requests Accepted: No

Note: Image(s) may not depict exact product or finishes, see item options.



Sheet Name
Furniture Specifications
Project
FLINT PUBLIC LIBRARY RENOVATION
1026 E. Kearsley St.,
Flint, MI 48503

OPN Project No. **17215000**
Sheet Issue Date **4/28/2021**
Section Number **19.0**
Item Code **PO-5**

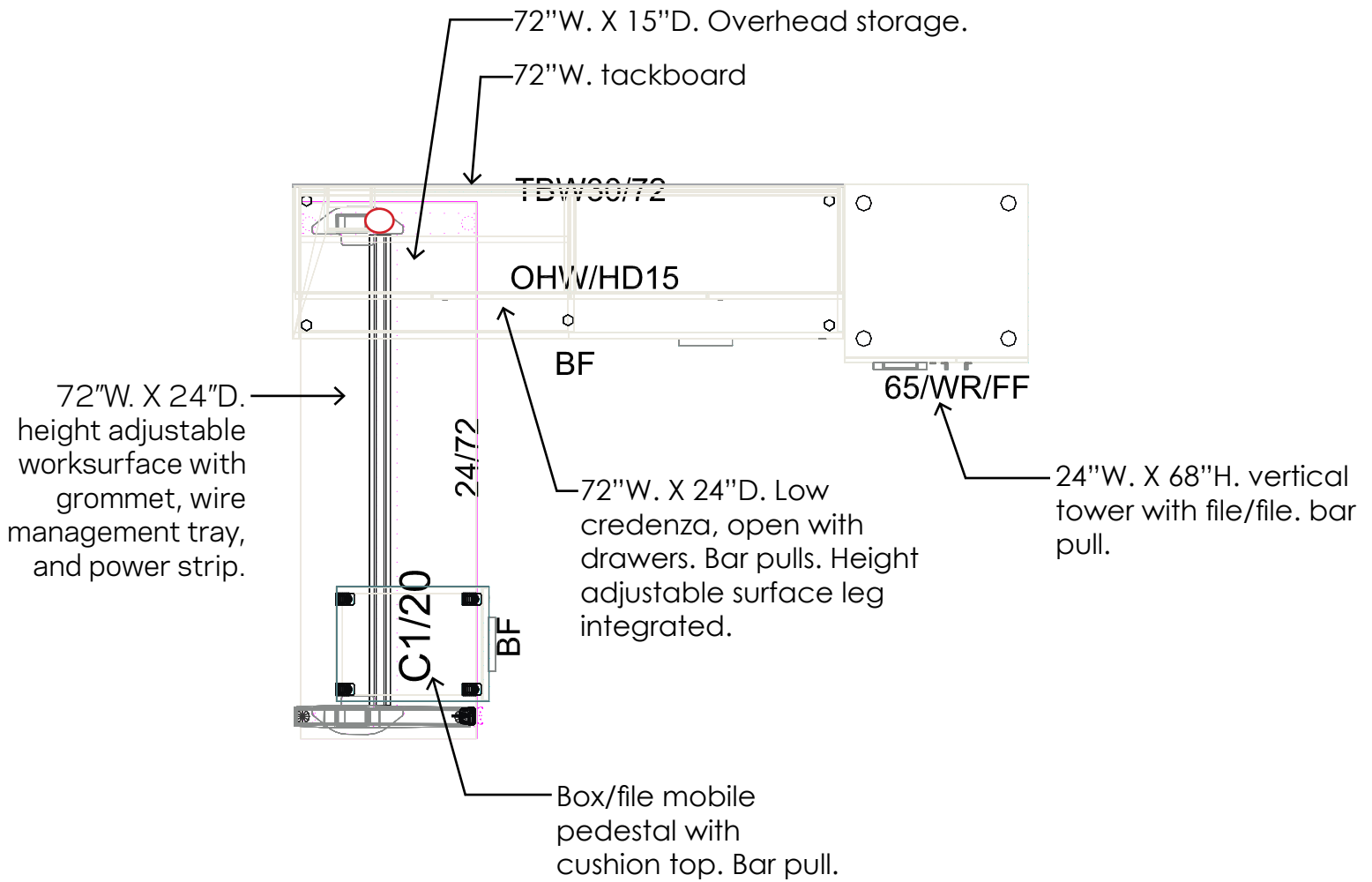

Item Information

Section Number 19.0
Item Code PO-6
Manufacturer Herman Miller
Model Canvas Private Office
Model Number --
Dimensions --
Description Private Office Type 6
Special Instructions Storage to be keyed alike per workstation.
See grommet locations on enlarged plan.

Item Options

Storage Finish 98 - Studio White
Worksurface Finish 98 - Studio White
Leg Finish MS - Metallic Silver
Tackable Fabric Whisper - Silver Pine
Ped File Cushion Fabric Geiger - Striae - Blue
Accessories Wire Management Tray
Power Strip w/ 10' Cord

Item Locations/Counts

ROOM NUMBER	ROOM NAME	COUNT
LOWER LEVEL		
139	OFFICE	1
COUNT TOTAL		1



Studio White
98



Metallic Silver
MS

Substitution Requests Accepted: No

Note: Image(s) may not depict exact product or finishes, see item options.



Sheet Name
Furniture Specifications
Project
FLINT PUBLIC LIBRARY RENOVATION
1026 E. Kearsley St.,
Flint, MI 48503

OPN Project No. **17215000**
Sheet Issue Date **4/28/2021**
Section Number **19.0**
Item Code **PO-6**

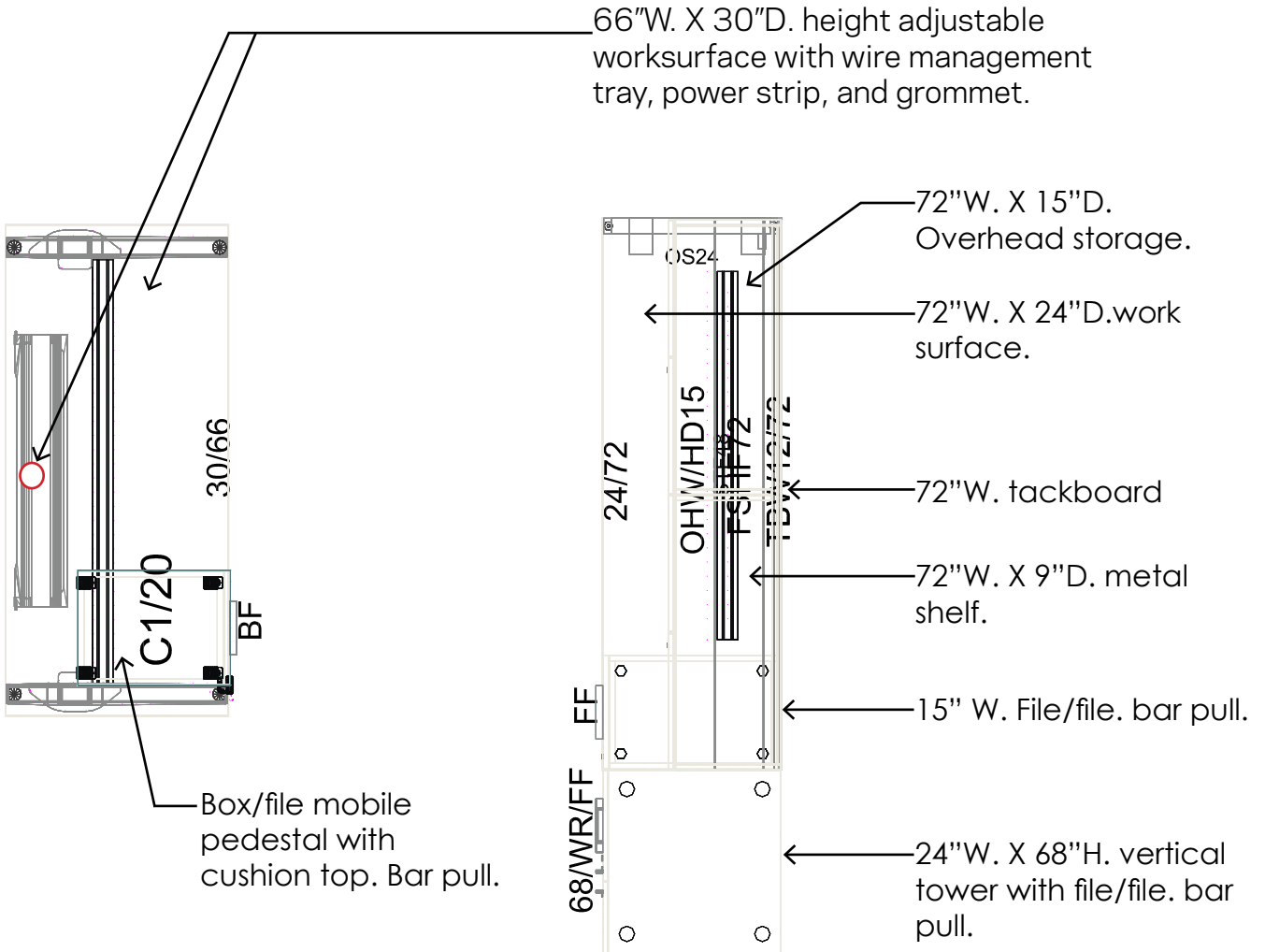

Item Information

Section Number 19.0
 Item Code S-3
 Manufacturer Herman Miller
 Model Tu Storage - W-Pull Storage Case
 Model Number LW400.36
 Dimensions 36"W. X 19 3/8"D. X 64"H.
 Description Metal storage case with shelves on interior.
 Special Instructions --

Item Options

Width 36 - 36" Wide
 Height 64 - 64" High
 Paint/Steel Type SS - Smooth paint on Smooth steel
 Surface Finish 98 - Studio White
 Interior NS4 - 4 Shelves Total
 Lock KC - Keyed differently, chrome

Item Locations/Counts

ROOM NUMBER	ROOM NAME	COUNT
LOWER LEVEL		
112B	SECURED STORAGE	2
113	STORAGE	1
COUNT TOTAL		3

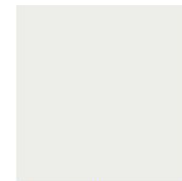
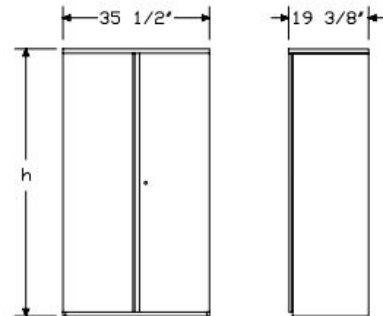
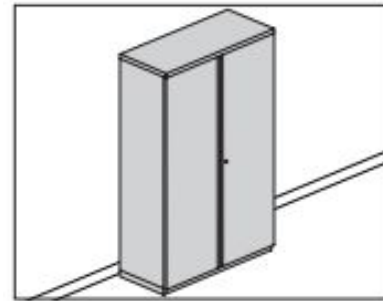

Studio White
98

Substitution Requests Accepted: Yes

Note: Image(s) may not depict exact product or finishes, see item options.



Sheet Name
Furniture Specifications
 Project
FLINT PUBLIC LIBRARY RENOVATION
 1026 E. Kearsley St.,
 Flint, MI 48503

OPN Project No. **17215000**
 Sheet Issue Date **4/28/2021**
 Section Number **19.0**
 Item Code **S-3**

Item Information

Section Number 19.0
 Item Code S-4
 Manufacturer Herman Miller
 Model Tu Storage - W-Pull Freestanding Lateral File
 Model Number LW200.36
 Dimensions 36"W. X 19 3/8"D. X 39 1/8"H.
 Description Metal lateral file with 3 drawers. 36" Wide.
 Special Instructions --

Item Options

Width 36 - 36" Wide
 Configuration 3 - 3 Drawers
 Paint/Steel Type SS - Smooth paint on Smooth steel
 Surface Finish 98 - Studio White
 Lock KC - Keyed Differently, chrome
 Counterweight CB - Counterweight
 Drawer Interior 2R - Side-to-side filing rail

Item Locations/Counts

ROOM NUMBER	ROOM NAME	COUNT
LOWER LEVEL		
112B	SECURED STORAGE	2
113	STORAGE	4
COUNT TOTAL		6

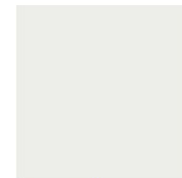
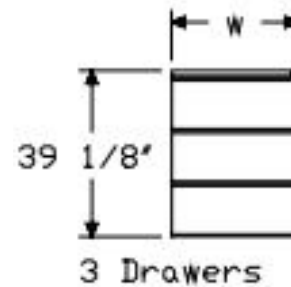
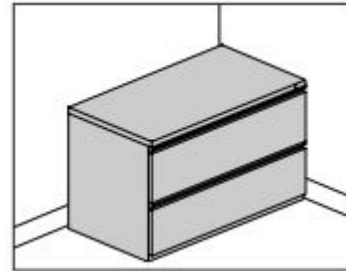

Studio White
98

Substitution Requests Accepted: Yes

Note: Image(s) may not depict exact product or finishes, see item options.

Item Information

Section Number 19.0
 Item Code S-5
 Manufacturer Herman Miller
 Model Tu Storage - W-Pull Freestanding Lateral File
 Model Number LW200.42
 Dimensions 42"W. X 19 3/8"D. X 39 1/8"H.
 Description Metal lateral file with 3 drawers. 42" Wide.
 Special Instructions --

Item Options

Width 42 - 42" Wide
 Configuration 3 - 3 Drawers
 Paint/Steel Type SS - Smooth paint on Smooth steel
 Surface Finish 98 - Studio White
 Lock KC - Keyed Differently, chrome
 Counterweight CB - Counterweight
 Drawer Interior 2R - Side-to-side filing rail

Item Locations/Counts

ROOM NUMBER	ROOM NAME	COUNT
LOWER LEVEL		
112B	SECURED STORAGE	1
113	STORAGE	1
COUNT TOTAL		2

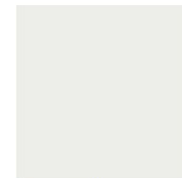
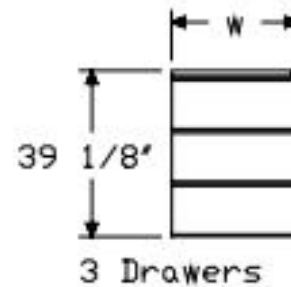
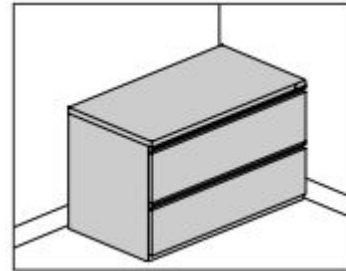

Studio White
98

Substitution Requests Accepted: Yes

Note: Image(s) may not depict exact product or finishes, see item options.



Sheet Name
Furniture Specifications
 Project
FLINT PUBLIC LIBRARY RENOVATION
 1026 E. Kearsley St.,
 Flint, MI 48503

OPN Project No. **17215000**
 Sheet Issue Date **4/28/2021**
 Section Number **19.0**
 Item Code **S-5**

Item Information

Section Number 19.0
 Item Code S-6
 Manufacturer Herman Miller
 Model Tu Storage - W-Pull Add-On Overfile
 Model Number LW410.36
 Dimensions 36"W. 19 3/8"D. X 26 1/8"H.
 Description Overfile installed on top of the Tu lateral file. 36" Wide.
 Special Instructions --

Item Options

Width 36 - 36" Wide
 Paint/Steel Type SS - Smooth paint on Smooth steel
 Surface Finish 98 - Studio White
 Lock KC - Keyed Differently, chrome

Item Locations/Counts

ROOM NUMBER	ROOM NAME	COUNT
LOWER LEVEL		
112B	SECURED STORAGE	2
113	STORAGE	4
COUNT TOTAL		6

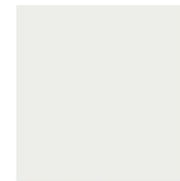
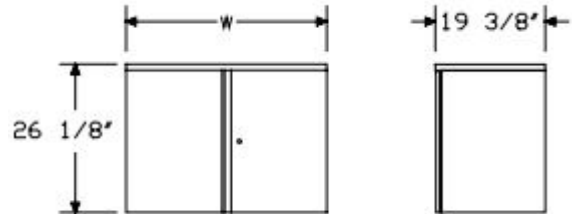
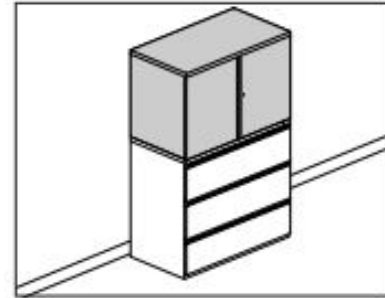

Studio White
98

Substitution Requests Accepted: Yes

Note: Image(s) may not depict exact product or finishes, see item options.

Item Information

Section Number 19.0
Item Code S-7
Manufacturer Herman Miller
Model Tu Storage - W-Pull Add-On Overfile
Model Number LW410.42
Dimensions 42"W. 19 3/8"D. X 26 1/8"H.
Description Overfile installed on top of the Tu lateral file. 42" Wide.
Special Instructions --

Item Options

Width 42 - 42" Wide
Paint/Steel Type SS - Smooth paint on Smooth steel
Surface Finish 98 - Studio White
Lock KC - Keyed Differently, chrome

Item Locations/Counts

ROOM NUMBER	ROOM NAME	COUNT
LOWER LEVEL		
112B	SECURED STORAGE	1
113	STORAGE	1
COUNT TOTAL		2

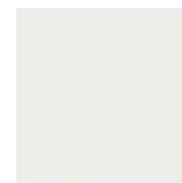
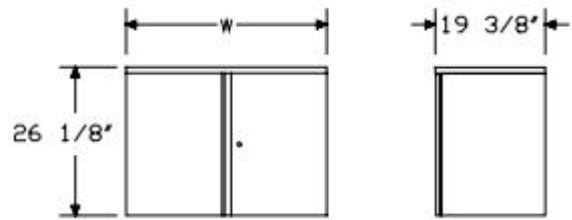
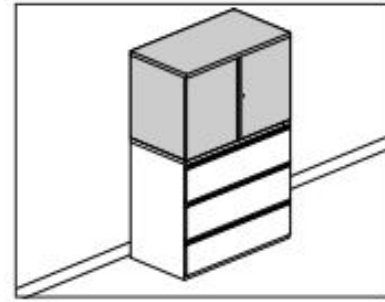

Studio White
98

Substitution Requests Accepted: Yes

Note: Image(s) may not depict exact product or finishes, see item options.

Item Information

Section Number 19.0
Item Code TC-1B
Manufacturer Herman Miller
Model Aeron Task Chair - Size B
Model Number AER1-B
Dimensions --
Description Task chair - size B.
Special Instructions --

Item Options

Size B - B Size
Height Adjustment 2 - Standard-height Range
Tilt 2 - Tilt Limiter
Arms H - Height-adjustable Arms
Armpad Upholstery W - Nonupholstered Armpads
Back Support Option ALP - Adjustable Posturefit SL
Frame Finish G1 - Graphite
Chassis Finish CD - Polished Aluminum
Base Finish CD - Polished Aluminum
Casters/Glides C7 - 2 1/2", black, hard floors or carpet
Armpad Finish BK - Black
8Z Pellicle 23103 - Graphite

Item Locations/Counts

ROOM NUMBER	ROOM NAME	COUNT
LOWER LEVEL		
101	STAFF	13
103	OFFICE	1
104	OFFICE	1
106	OFFICE	1
107	OFFICE	1
108	OFFICE	1
109	OFFICE	1
110	OFFICE	1
111	OFFICE	2
112A	OFFICE	1
112B	SECURED STORAGE	1
113	STORAGE	1
125	SHIPPING & RECEIVING	3
135	TECH SERVICES/ LOAN WORK ROOM	3
136	OFFICE	1
139	OFFICE	1
140	STORAGE	1
COUNT TOTAL		34



Substitution Requests Accepted: No

Note: Image(s) may not depict exact product or finishes, see item options.



Sheet Name
Furniture Specifications
Project
FLINT PUBLIC LIBRARY RENOVATION
1026 E. Kearsley St.,
Flint, MI 48503

OPN Project No. **17215000**
Sheet Issue Date **4/28/2021**
Section Number **19.0**
Item Code **TC-1B**

Item Information

Section Number 19.0
Item Code TC-1C
Manufacturer Herman Miller
Model Aeron Task Chair - Size C
Model Number AER1-C
Dimensions --
Description Task chair - size C.
Special Instructions --

Item Options

Size C - C Size
Height Adjustment 2 - Standard-height Range
Tilt 2 - Tilt Limiter
Arms H - Height-adjustable Arms
Armpad Upholstery W - Nonupholstered Armpads
Back Support Option ALP - Adjustable Posturefit SL
Frame Finish G1 - Graphite
Chassis Finish CD - Polished Aluminum
Base Finish CD - Polished Aluminum
Casters/Glides C7 - 2 1/2", black, hard floors or carpet
Armpad Finish BK - Black
8Z Pellicle 23103 - Graphite

Item Locations/Counts

ROOM NUMBER	ROOM NAME	COUNT
LOWER LEVEL		
101	STAFF	8
135	TECH SERVICES/ LOAN WORK ROOM	1
COUNT TOTAL		9



Substitution Requests Accepted: No

Note: Image(s) may not depict exact product or finishes, see item options.



Sheet Name
Furniture Specifications
Project
FLINT PUBLIC LIBRARY RENOVATION
1026 E. Kearsley St.,
Flint, MI 48503

OPN Project No. **17215000**
Sheet Issue Date **4/28/2021**
Section Number **19.0**
Item Code **TC-1C**

Item Information

Section Number 19.0
Item Code TC-2
Manufacturer Herman Miller
Model Cosm Conference Chair
Model Number FLC3-6
Dimensions --
Description Dipped in color, high back work chair.
Special Instructions --

Item Options

Back Height 6 - High Back
Height Adjustment 2 - Standard-height Range
Tilt S - Auto-harmonic Tilt
Seat Depth F - Fixed Seat Depth
Arms P - Fixed Arms
Full Color DN2 - Nightfall
Chassis Finish DN2 - Nightfall
Base Finish DN2 - Nightfall
Casters/Glides O2N - 2.5", hard floor or carpet - nightfall
Intercept Suspension 84504 - Nightfall
Material

Item Locations/Counts

ROOM NUMBER	ROOM NAME	COUNT
LOWER LEVEL		
105	CONFERENCE ROOM	6
UPPER LEVEL		
304	CONFERENCE ROOM	14
COUNT TOTAL		20



Substitution Requests Accepted: No

Note: Image(s) may not depict exact product or finishes, see item options.

Item Information

Section Number 19.0
 Item Code WS-1
 Manufacturer Herman Miller
 Model Canvas Workstation
 Model Number --
 Dimensions --
 Description Work station with height adjustable table, storage tower, and credenza with cushion top.
 Special Instructions --

Item Options

Storage Finish 98 - Studio White
 Worksurface Finish 98 - Studio White
 Leg Finish MS - Metallic Silver
 Tackable Fabric Whisper - Silver Pine
 Credenza Cushion Fabric Geiger - Striae - Blue
 Panel Fabric 2V01 - Chain - Pearl
 Glass Finish C3 - Clear Glass

Item Locations/Counts

ROOM NUMBER	ROOM NAME	COUNT
LOWER LEVEL		
101	STAFF	8
COUNT TOTAL		8

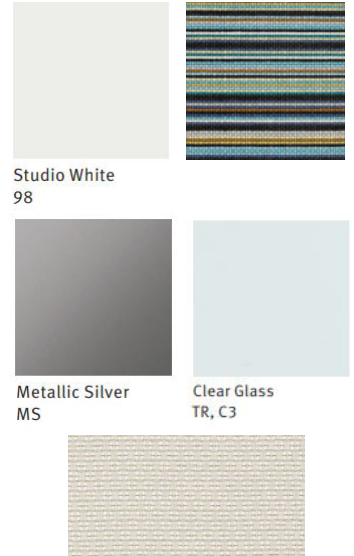

Substitution Requests Accepted: No

Note: Image(s) may not depict exact product or finishes, see item options.



Sheet Name
Furniture Specifications
 Project
FLINT PUBLIC LIBRARY RENOVATION
 1026 E. Kearsley St.,
 Flint, MI 48503

OPN Project No. **17215000**
 Sheet Issue Date **4/28/2021**
 Section Number **19.0**
 Item Code **WS-1**

53" high panel + 11" high glass screen - Chain, Pearl panel fabric. Typ.

53" high personal storage tower. Storage to be keyed alike per station.

24" D. X 60" W. height adjustable worksurface with grommet and wire management tray.

48" wide low credenza, open with drawers + 30" wide cushion top - Geiger Striae - blue. Storage to be keyed alike per station.

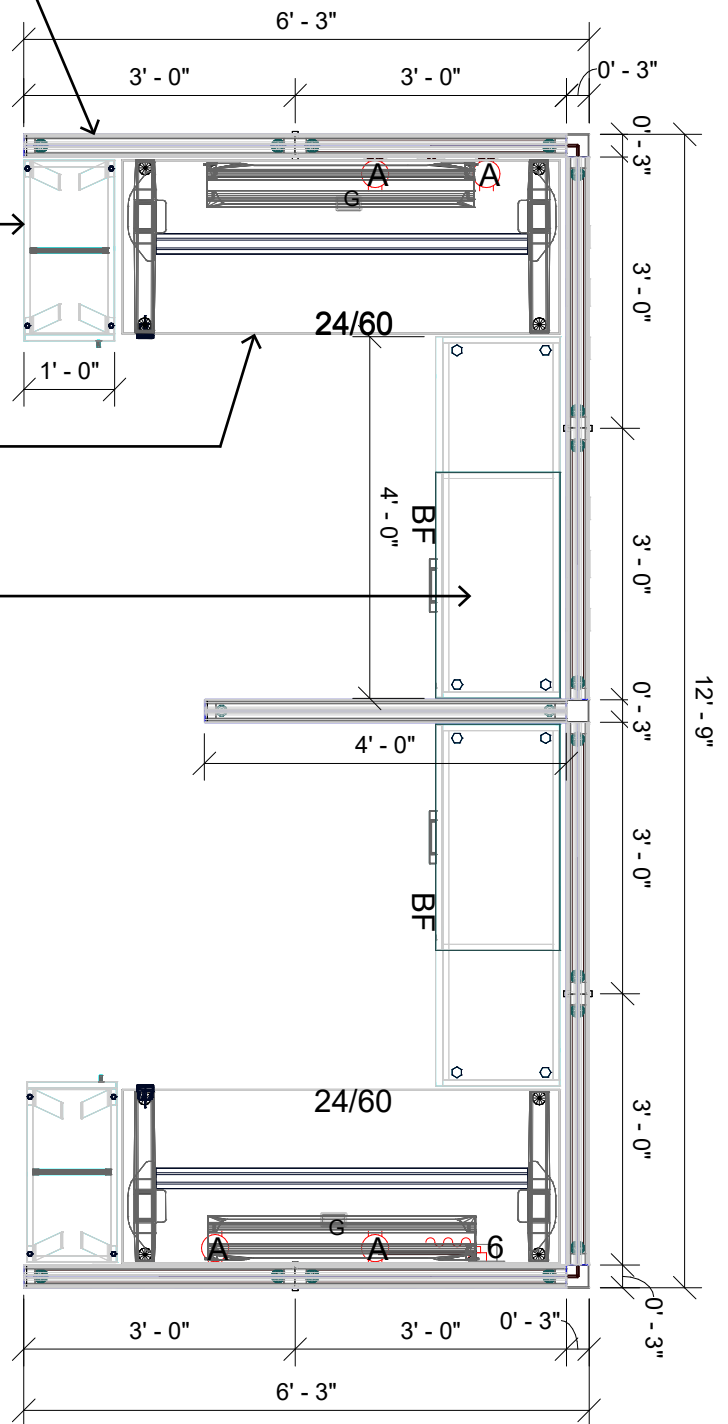

Sheet Name
Furniture Specifications

Project
FLINT PUBLIC LIBRARY RENOVATION

1026 E. Kearsley St.,
 Flint, MI 48503

OPN Project No. **17215000**

Sheet Issue Date **03/30/21**

Section Number

Item Code **WS-1(2)**

Item Information

Section Number 19.0
Item Code WS-2A
Manufacturer Herman Miller
Model Prospect Solo Structure
Model Number CBSC-04
Dimensions 66 7/16" Dia. X 54"H.
Description Solo hoteling work station.
Special Instructions --

Item Options

Configuration 04 - 4-Panel
Height 54 - 54" High
Support and Foot Finish 98 - Studio White
Interior Panel Surface BB - Whiteboard
Type
Exterior Panel Finish 8Q - Folkstone Grey
Nonupholstered Acoustic PMG - Medium Heathered Grey
Pad Color

Item Locations/Counts

ROOM NUMBER	ROOM NAME	COUNT
LOWER LEVEL		
101	STAFF	4
COUNT TOTAL		4

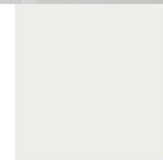

Studio White
98

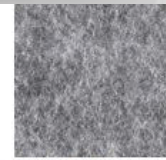

Medium Heathered
Grey
PMG

Substitution Requests Accepted: No

Note: Image(s) may not depict exact product or finishes, see item options.

Item Information

Section Number 19.0
Item Code WS-2B
Manufacturer Herman Miller
Model Prospect Solo Surface
Model Number CBSCS-04
Dimensions --
Description Solo hoteling work surface.
Special Instructions --

Item Options

Configuration 04 - 4-panel
Edge T - Thin Edge
Surface Material L - Laminate
Electrical Access R - Power cutout for round, 2 port power unit
Surface Ledge Finish 98 - Studio White

Item Locations/Counts

ROOM NUMBER	ROOM NAME	COUNT
LOWER LEVEL		
101	STAFF	4
COUNT TOTAL		4

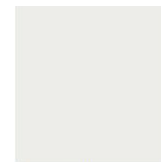

Studio White
98

Substitution Requests Accepted: No

Note: Image(s) may not depict exact product or finishes, see item options.

Item Information

Section Number 19.0
Item Code WS-3
Manufacturer Herman Miller
Model Layout Studio Benching
Model Number --
Dimensions 14'-0"W. X 4'-0"D.
Description Public computer station type 1. Seated height.
Special Instructions --

Item Options

Worksurface Finish 8Q - Folkstone Grey
Leg Finish MS - Metallic Silver
Glass Finish G3 - Opal Glass
Access Door Finish MS - Metallic Silver
-

Item Locations/Counts

ROOM NUMBER	ROOM NAME	COUNT
LOWER LEVEL		
132	LOCAL HISTORY & GENEALOGY	1
UPPER LEVEL		
306	PUBLIC ACCESS COMPUTERS	3
COUNT TOTAL		4

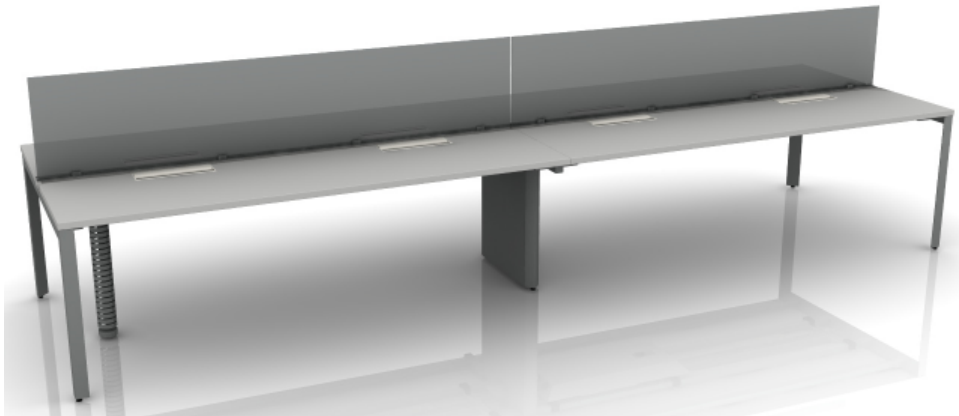

Substitution Requests Accepted: No

Note: Image(s) may not depict exact product or finishes, see item options.



Sheet Name
Furniture Specifications
Project
FLINT PUBLIC LIBRARY RENOVATION
1026 E. Kearsley St.,
Flint, MI 48503

OPN Project No. **17215000**
Sheet Issue Date **4/28/2021**
Section Number **19.0**
Item Code **WS-3**

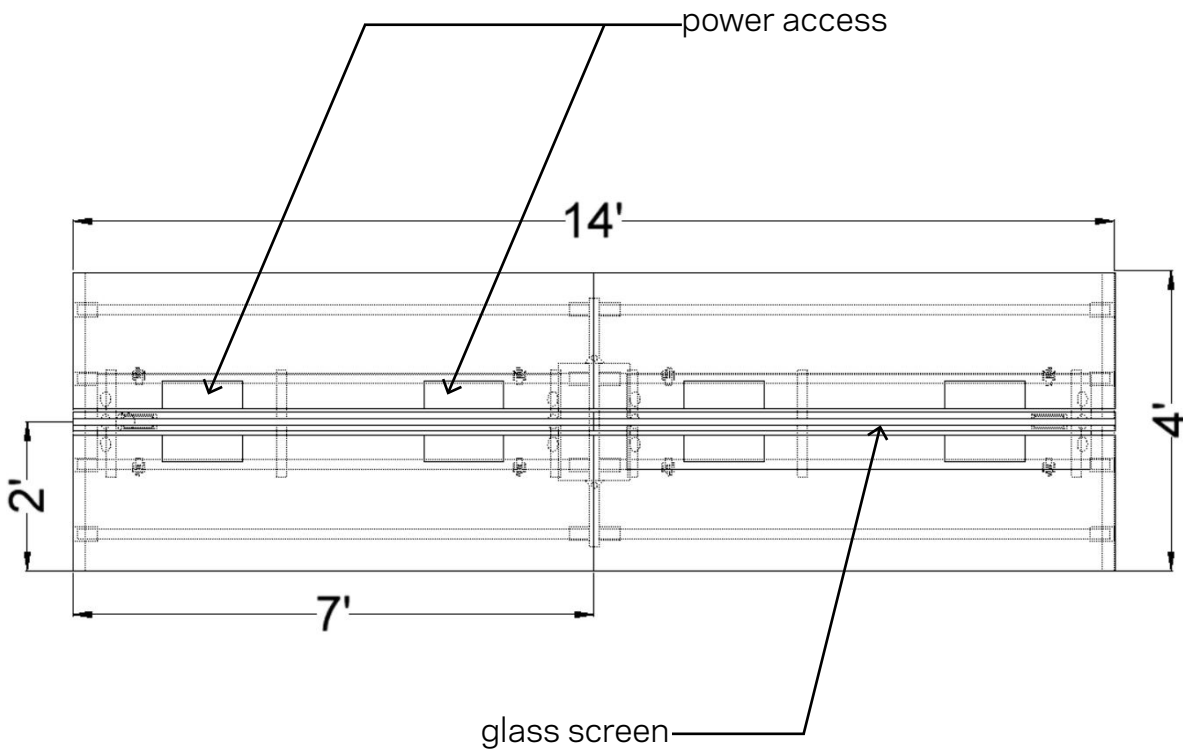

Item Information

Section Number 19.0
Item Code WS-4
Manufacturer Herman Miller
Model Layout Studio Benching
Model Number --
Dimensions 12'-0"W. X 4'-0"D. X 2'-3"H.
Description Public computer station type 2 - Children's. Lower height surface.
Special Instructions --

Item Options

Worksurface Finish 8Q - Folkstone Grey
Leg Finish MS - Metallic Silver
Glass Finish G3 - Opal Glass
Access Door Finish MS - Metallic Silver
-

Item Locations/Counts

ROOM NUMBER	ROOM NAME	COUNT
MAIN LEVEL		
212	CHILDREN'S COLLECTION	1
COUNT TOTAL		1

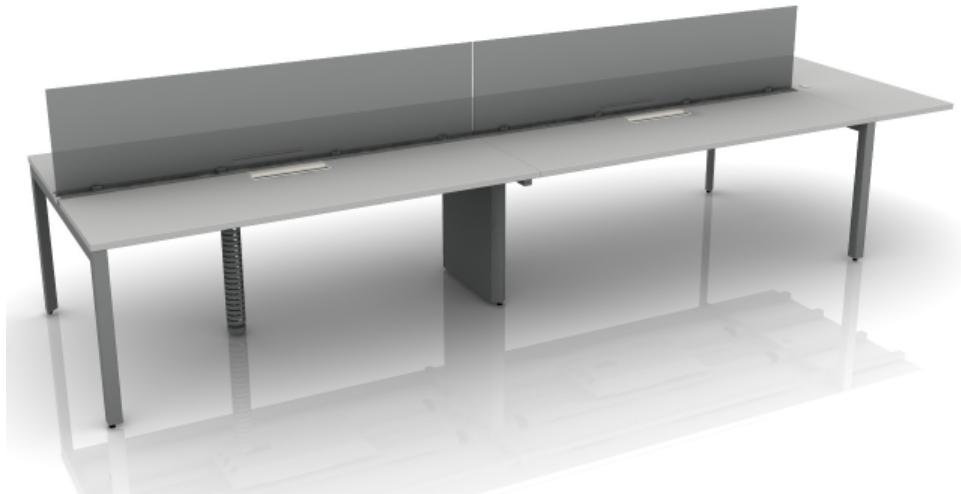

Substitution Requests Accepted: No

Note: Image(s) may not depict exact product or finishes, see item options.



Sheet Name
Furniture Specifications
Project
FLINT PUBLIC LIBRARY RENOVATION
1026 E. Kearsley St.,
Flint, MI 48503

OPN Project No. **17215000**
Sheet Issue Date **4/28/2021**
Section Number **19.0**
Item Code **WS-4**

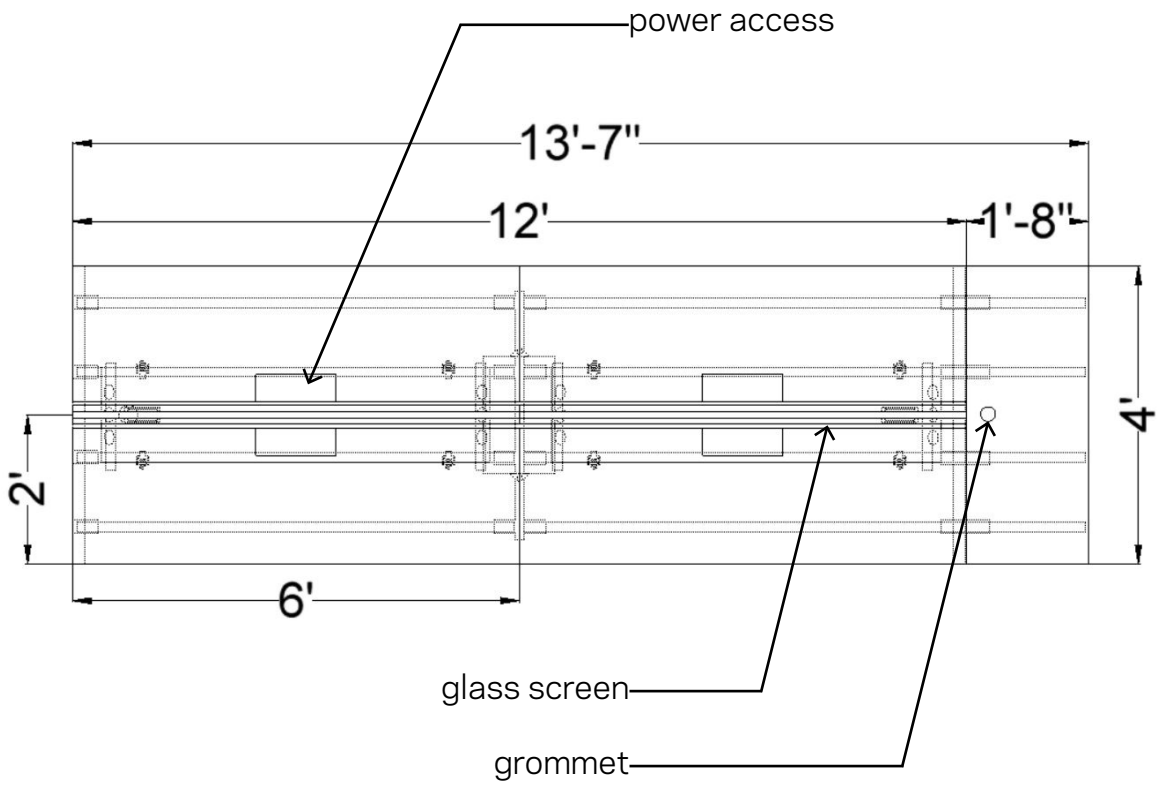

Item Information

Section Number 19.0
Item Code WS-5
Manufacturer Herman Miller
Model Layout Studio Benching
Model Number --
Dimensions 10'-6"W. X 4'-0"D.
Description Public computer station type 3. Seated height.
Special Instructions --

Item Options

Worksurface Finish 8Q - Folkstone Grey
Leg Finish MS - Metallic Silver
Glass Finish G3 - Opal Glass
Access Door Finish MS - Metallic Silver
-

Item Locations/Counts

ROOM NUMBER	ROOM NAME	COUNT
LOWER LEVEL		
134	SPECIAL COLLECTIONS	1
COUNT TOTAL		1

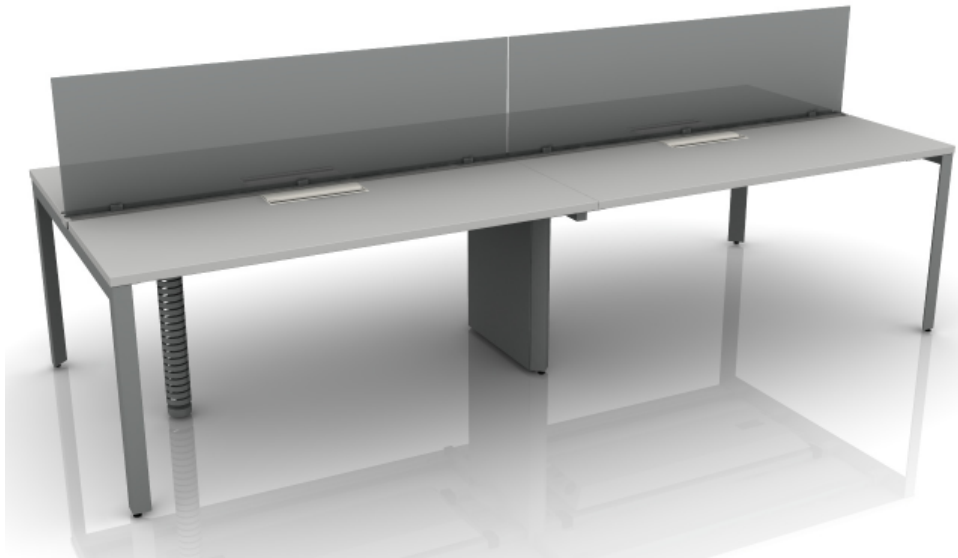

Substitution Requests Accepted: No

Note: Image(s) may not depict exact product or finishes, see item options.



Sheet Name
Furniture Specifications
Project
FLINT PUBLIC LIBRARY RENOVATION
1026 E. Kearsley St.,
Flint, MI 48503

OPN Project No. **17215000**
Sheet Issue Date **4/28/2021**
Section Number **19.0**
Item Code **WS-5**

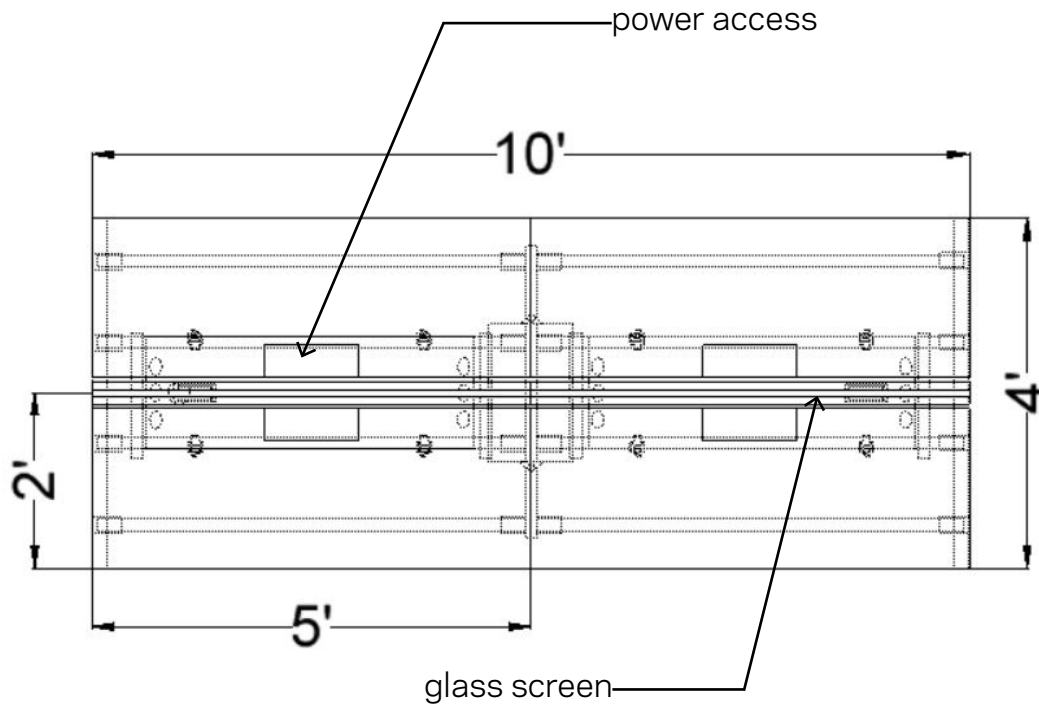

Item Information

Section Number 19.0
Item Code WS-6
Manufacturer Herman Miller
Model Canvas Desking
Model Number --
Dimensions 12'-0"W.X 2'-6"D.
Description Two 6' surfaces with shared leg.
Special Instructions --

Item Options

Worksurface Finish 98 - Studio White
Leg Finish MS - Metallic Silver
Grommet Finish 98 - Studio White

Item Locations/Counts

ROOM NUMBER	ROOM NAME	COUNT
LOWER LEVEL		
125	SHIPPING & RECEIVING	1
135	TECH SERVICES/ LOAN WORK ROOM	1
140	STORAGE	1
COUNT TOTAL		3

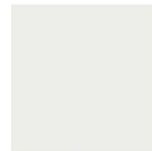

Studio White
98



Metallic Silver
MS

Substitution Requests Accepted: No

Note: Image(s) may not depict exact product or finishes, see item options.



Sheet Name
Furniture Specifications
Project
FLINT PUBLIC LIBRARY RENOVATION
1026 E. Kearsley St.,
Flint, MI 48503

OPN Project No. **17215000**
Sheet Issue Date **4/28/2021**
Section Number **19.0**
Item Code **WS-6**

Item Information

Section Number 19.0
Item Code WS-7
Manufacturer Herman Miller
Model Canvas Desking
Model Number --
Dimensions 14'-0"W.X 2'-6"D.
Description Two 7' surfaces with shared leg.
Special Instructions --

Item Options

Worksurface Finish 98 - Studio White
Leg Finish MS - Metallic Silver
Grommet Finish 99 - Studio White

Item Locations/Counts

ROOM NUMBER	ROOM NAME	COUNT
LOWER LEVEL		
125	SHIPPING & RECEIVING	1
135	TECH SERVICES/ LOAN WORK ROOM	1
COUNT TOTAL		2

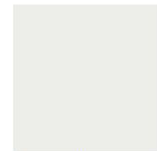
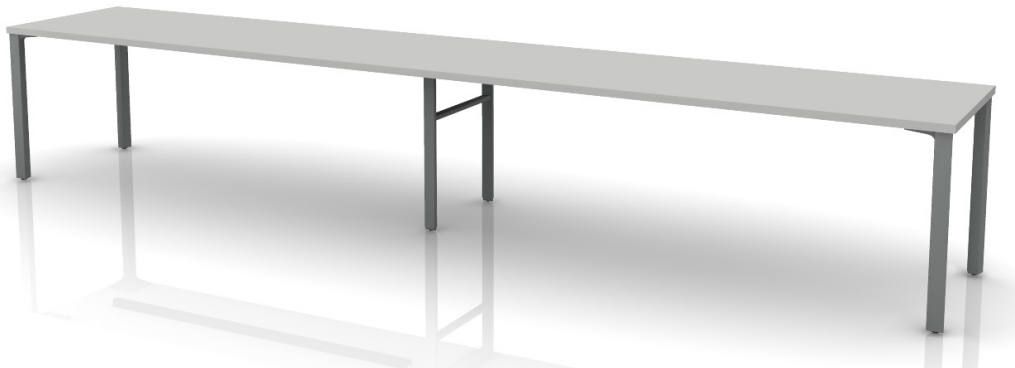

Studio White
98



Metallic Silver
MS

Substitution Requests Accepted: No

Note: Image(s) may not depict exact product or finishes, see item options.

Item Information

Section Number 19.0
Item Code WS-8
Manufacturer Herman Miller
Model Canvas Desking
Model Number --
Dimensions --
Description L shape desk.
Special Instructions --

Item Options

Worksurface Finish 98 - Studio White
Leg Finish MS - Metallic Silver
Grommet Finish 100 - Studio White

Item Locations/Counts

ROOM NUMBER	ROOM NAME	COUNT
LOWER LEVEL		
135	TECH SERVICES/ LOAN WORK ROOM	1
COUNT TOTAL		1

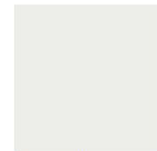

Studio White
98



Metallic Silver
MS

Substitution Requests Accepted: No

Note: Image(s) may not depict exact product or finishes, see item options.



Sheet Name
Furniture Specifications
Project
FLINT PUBLIC LIBRARY RENOVATION
1026 E. Kearsley St.,
Flint, MI 48503

OPN Project No. **17215000**
Sheet Issue Date **4/28/2021**
Section Number **19.0**
Item Code **WS-8**

24" D. X 90" W. worksurface with grommet, wire management tray and power strip.

24" D. X 60" W. worksurface

flash gap for cord pass through

24" D. X 60" W. worksurface

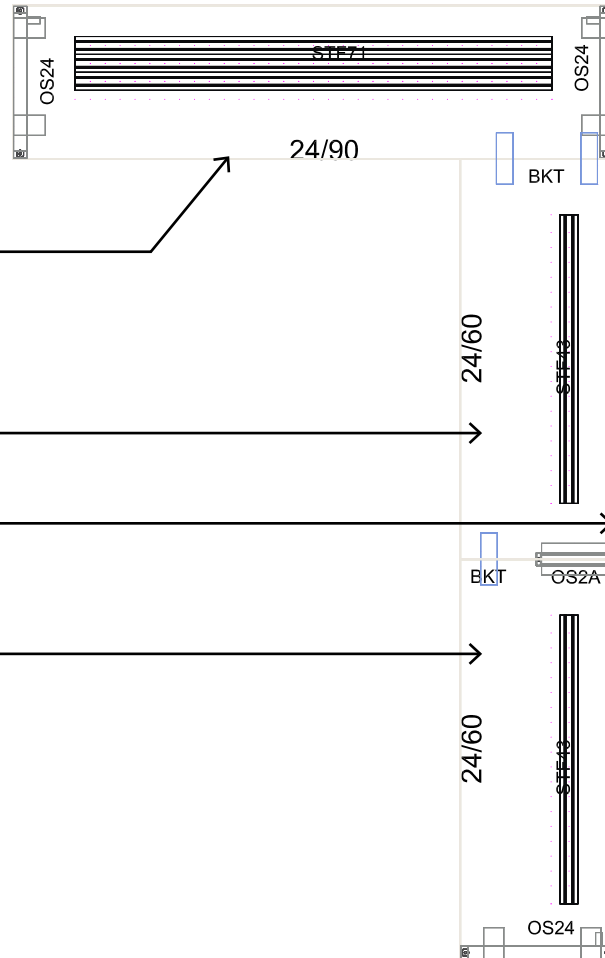

Sheet Name
Furniture Specifications
Project
FLINT PUBLIC LIBRARY RENOVATION
1026 E. Kearsley St.,
Flint, MI 48503

OPN Project No. **17215000**
Sheet Issue Date **03/30/21**
Section Number
Item Code **WS-8(2)**

Item Information

Section Number 20.0
Item Code LC-11
Manufacturer Hightower
Model Capri Lounge
Model Number GZ3400
Dimensions --
Description Upholstered lounge chair with wood legs.
Special Instructions --

Item Options

Fabric Architex - Wardrobe - Raven
Wood Finish Clear Lacquered Oak

Item Locations/Counts

ROOM NUMBER	ROOM NAME	COUNT
MAIN LEVEL		
202	ADULT - FICTION	4
COUNT TOTAL		4



Clear
Lacquered Oak

Substitution Requests Accepted: Yes

Note: Image(s) may not depict exact product or finishes, see item options.



Sheet Name
Furniture Specifications
Project
FLINT PUBLIC LIBRARY RENOVATION
1026 E. Kearsley St.,
Flint, MI 48503

OPN Project No. **17215000**
Sheet Issue Date **4/28/2021**
Section Number **20.0**
Item Code **LC-11**

Item Information

Section Number 20.0
Item Code LC-12
Manufacturer Hightower
Model Capri Lounge
Model Number GZ3400
Dimensions --
Description Upholstered lounge chair with wood legs.
Special Instructions --

Item Options

Fabric Kvadrat - Divina Melange 3 - 747.0
Wood Finish Clear Lacquered Oak

Item Locations/Counts

ROOM NUMBER	ROOM NAME	COUNT
UPPER LEVEL		
303	UNCONFERENCE ROOM	2
COUNT TOTAL		2



Clear
Lacquered Oak

Substitution Requests Accepted: Yes

Note: Image(s) may not depict exact product or finishes, see item options.

Item Information

Section Number 20.0
Item Code LC-13
Manufacturer Hightower
Model Happy Lounge Chair
Model Number SH-1055
Dimensions --
Description Upholstered lounge chair with wood legs.
Special Instructions *Provide alta + moisture barrier backing*

Item Options

Fabric Kvadrat - Coda - 762
Wood Finish Oak

Item Locations/Counts

ROOM NUMBER	ROOM NAME	COUNT
LOWER LEVEL		
101	STAFF	3
COUNT TOTAL		3

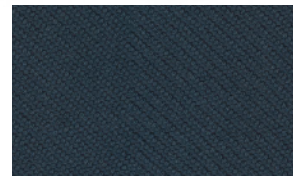

Substitution Requests Accepted: Yes

Note: Image(s) may not depict exact product or finishes, see item options.

Item Information

Section Number 21.0
Item Code LC-14
Manufacturer IOA
Model Breeze Rocker - Stainless Steel Frame - Mesh Back
Model Number 363RK-SS
Dimensions --
Description Rocking chair with upholstered seat & arms, mesh back, and stainless steel legs.
Special Instructions --

Item Options

Mesh Color Helsinki -
Fabric Wolf Gordon - Tallinn - Cumulus

Item Locations/Counts

ROOM NUMBER	ROOM NAME	COUNT
LOWER LEVEL		
124	MOTHER'S ROOM	1
MAIN LEVEL		
228	NEW MOM'S RM	1
COUNT TOTAL		2

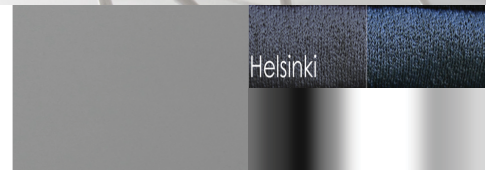

Substitution Requests Accepted: Yes

Note: Image(s) may not depict exact product or finishes, see item options.

Item Information

Section Number 21.0
Item Code O-7
Manufacturer IOA
Model Fun Forms Ottoman - "Splat"
Model Number FP-01
Dimensions --
Description Upholstered Ottoman.
Special Instructions --

Item Options

Fabric Luum - Color Fuse - Enamel

Item Locations/Counts

ROOM NUMBER	ROOM NAME	COUNT
MAIN LEVEL		
212	CHILDREN'S COLLECTION	1
COUNT TOTAL		1

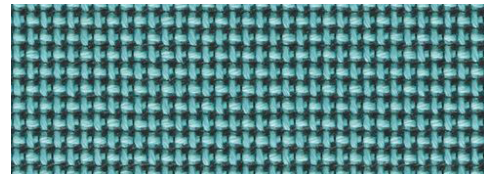

Substitution Requests Accepted: Yes

Note: Image(s) may not depict exact product or finishes, see item options.



Sheet Name
Furniture Specifications
Project
FLINT PUBLIC LIBRARY RENOVATION
1026 E. Kearsley St.,
Flint, MI 48503

OPN Project No. **17215000**
Sheet Issue Date **4/28/2021**
Section Number **21.0**
Item Code **O-7**

Item Information

Section Number 21.0
Item Code O-8
Manufacturer IOA
Model Fun Forms Ottoman - "Splat"
Model Number FP-01
Dimensions --
Description Upholstered Ottoman.
Special Instructions --

Item Options

Fabric Luum - Color Fuse - Molten

Item Locations/Counts

ROOM NUMBER	ROOM NAME	COUNT
MAIN LEVEL		
212	CHILDREN'S COLLECTION	1
COUNT TOTAL		1

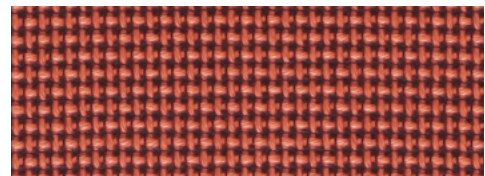

Substitution Requests Accepted: Yes

Note: Image(s) may not depict exact product or finishes, see item options.



Sheet Name
Furniture Specifications
Project
FLINT PUBLIC LIBRARY RENOVATION
1026 E. Kearsley St.,
Flint, MI 48503

OPN Project No. **17215000**
Sheet Issue Date **4/28/2021**
Section Number **21.0**
Item Code **O-8**

Item Information

Section Number 22.0
Item Code LC-15
Manufacturer JSI
Model Caav Lounge - Single Seat with Privacy
Model Number Surround
Dimensions CVF3540-52
Description --
Lounge chair with contrasting upholstery,
privacy surround, power integration,
and wood legs.
Special Instructions --

Item Options

Wood Species WAL - Walnut
Wood Finish MCH - Mocha
Fabric - (A) Chair HBF - Sable Island - 80 Overcast
Fabric - (B) Privacy Carnegie - Dotty - 4
Surround
Tablet Arm No -
Power Unit PUR - EC46 - Power Unit Right -
Flush Mount
Power Unit Color B - Black

Item Locations/Counts

ROOM NUMBER	ROOM NAME	COUNT
MAIN LEVEL		
209	YOUNG ADULT	2
COUNT TOTAL		2



Substitution Requests Accepted: Yes

Note: Image(s) may not depict exact product or finishes, see item options.



Sheet Name
Furniture Specifications
Project
FLINT PUBLIC LIBRARY RENOVATION
1026 E. Kearsley St.,
Flint, MI 48503

OPN Project No. **17215000**
Sheet Issue Date **4/28/2021**
Section Number **22.0**
Item Code **LC-15**

Item Information

Section Number 22.0
Item Code O-9
Manufacturer JSI
Model Caav Ottoman
Model Number CVO1623-12
Dimensions --
Description Upholstered ottoman - Pairs with Caav lounge chair.
Special Instructions --

Item Options

Fabric HBF - Sable Island - 80 Overcast

Item Locations/Counts

ROOM NUMBER	ROOM NAME	COUNT
MAIN LEVEL		
209	YOUNG ADULT	2
COUNT TOTAL		2



Substitution Requests Accepted: Yes

Note: Image(s) may not depict exact product or finishes, see item options.



Sheet Name
Furniture Specifications
Project
FLINT PUBLIC LIBRARY RENOVATION
1026 E. Kearsley St.,
Flint, MI 48503

OPN Project No. **17215000**
Sheet Issue Date **4/28/2021**
Section Number **22.0**
Item Code **O-9**

Item Information

Section Number 23.0
Item Code LC-16
Manufacturer Keilhauer
Model Cahoots Lounge
Model Number 9002.0
Dimensions --
Description Upholstered lounge chair with contrasting fabric and swivel base.
Special Instructions --

Item Options

Seat Fabric Wolf Gordon - Belize - Aegean
Back Fabric Momentum - Mandala - Aruba
Frame Finish PC00 - Nickel

Item Locations/Counts

ROOM NUMBER	ROOM NAME	COUNT
MAIN LEVEL		
212	CHILDREN'S COLLECTION	10
COUNT TOTAL		10

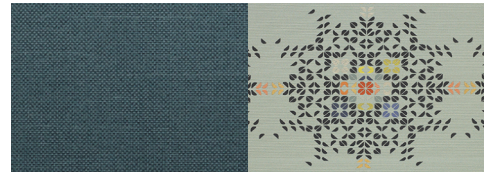

Substitution Requests Accepted: Yes

Note: Image(s) may not depict exact product or finishes, see item options.



Sheet Name
Furniture Specifications
Project
FLINT PUBLIC LIBRARY RENOVATION
1026 E. Kearsley St.,
Flint, MI 48503

OPN Project No. **17215000**
Sheet Issue Date **4/28/2021**
Section Number **23.0**
Item Code **LC-16**

Item Information

Section Number 23.0
Item Code LC-17
Manufacturer Keilhauer
Model Coy Lounge
Model Number 71160.0
Dimensions --
Description High back lounge chair with wood base.
Special Instructions --

Item Options

Fabric HBF - Vault Lights - 56 Old City
Wood Finish WAN - Walnut

Item Locations/Counts

ROOM NUMBER	ROOM NAME	COUNT
UPPER LEVEL		
306	PUBLIC ACCESS COMPUTERS	4
COUNT TOTAL		4

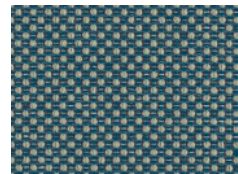

Natural Walnut
WAN

Substitution Requests Accepted: Yes

Note: Image(s) may not depict exact product or finishes, see item options.



Sheet Name
Furniture Specifications
Project
FLINT PUBLIC LIBRARY RENOVATION
1026 E. Kearsley St.,
Flint, MI 48503

OPN Project No. **17215000**
Sheet Issue Date **4/28/2021**
Section Number **23.0**
Item Code **LC-17**

Item Information

Section Number 23.0
Item Code LC-18
Manufacturer Keilhauer
Model Lo Lounge
Model Number 14100.0
Dimensions --
Description Upholstered lounge seat with metal base.
Special Instructions --

Item Options

Fabric HBF - Madam Dottie - 40 Modest
Frame Finish Chrome

Item Locations/Counts

ROOM NUMBER	ROOM NAME	COUNT
MAIN LEVEL		
209	YOUNG ADULT	2
COUNT TOTAL		2

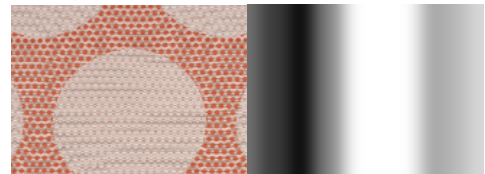

Substitution Requests Accepted: Yes

Note: Image(s) may not depict exact product or finishes, see item options.



Sheet Name
Furniture Specifications
Project
FLINT PUBLIC LIBRARY RENOVATION
1026 E. Kearsley St.,
Flint, MI 48503

OPN Project No. **17215000**
Sheet Issue Date **4/28/2021**
Section Number **23.0**
Item Code **LC-18**

Item Information

Section Number 23.0
Item Code LC-19
Manufacturer Keilhauer
Model Lo Lounge
Model Number 14100.0
Dimensions --
Description Upholstered lounge seat with metal base.
Special Instructions --

Item Options

Fabric Designtex - Tack Cloth - Campfire
Frame Finish Chrome

Item Locations/Counts

ROOM NUMBER	ROOM NAME	COUNT
MAIN LEVEL		
209	YOUNG ADULT	1
COUNT TOTAL		1

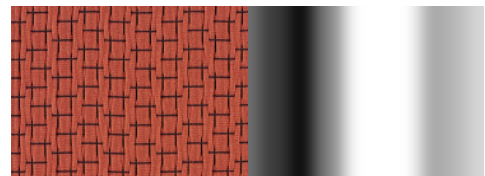

Substitution Requests Accepted: Yes

Note: Image(s) may not depict exact product or finishes, see item options.



Sheet Name
Furniture Specifications
Project
FLINT PUBLIC LIBRARY RENOVATION
1026 E. Kearsley St.,
Flint, MI 48503

OPN Project No. **17215000**
Sheet Issue Date **4/28/2021**
Section Number **23.0**
Item Code **LC-19**

Item Information

Section Number 24.0
Item Code A-4
Manufacturer Knoll - Muuto
Model Restore Basket
Model Number --
Dimensions 13.75" X 19"D. X 9"H
Description Felt storage bin.
Special Instructions --

Item Options

Color Grey

Item Locations/Counts

ROOM NUMBER	ROOM NAME	COUNT
MAIN LEVEL		
212	CHILDREN'S COLLECTION	6
COUNT TOTAL		6



Substitution Requests Accepted: Yes

Note: Image(s) may not depict exact product or finishes, see item options.

Item Information

Section Number 24.0
Item Code LC-20
Manufacturer Knoll
Model Womb Chair
Model Number 70L-C
Dimensions --
Description upholstered lounge chair with chrome base.
Special Instructions *Provide Nanotex + moisture barrier backing*

Item Options

Fabric Bernhardt - Babayee - Sky
Frame Finish C - Polished Chrome

Item Locations/Counts

ROOM NUMBER	ROOM NAME	COUNT
LOWER LEVEL		
116	BREAK ROOM	2
COUNT TOTAL		2

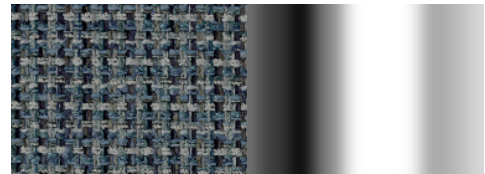

Substitution Requests Accepted: Yes

Note: Image(s) may not depict exact product or finishes, see item options.



Sheet Name
Furniture Specifications
Project
FLINT PUBLIC LIBRARY RENOVATION
1026 E. Kearsley St.,
Flint, MI 48503

OPN Project No. **17215000**
Sheet Issue Date **4/28/2021**
Section Number **24.0**
Item Code **LC-20**

Item Information

Section Number 24.0
Item Code O-10
Manufacturer Knoll
Model Womb Ottoman
Model Number 74Y-C
Dimensions --
Description Upholstered ottoman - Pairs with Womb chair.
Special Instructions --

Item Options

Fabric Bernhardt - Babayee - Sky
Frame Finish C - Polished Chrome

Item Locations/Counts

ROOM NUMBER	ROOM NAME	COUNT
LOWER LEVEL		
116	BREAK ROOM	2
COUNT TOTAL		2

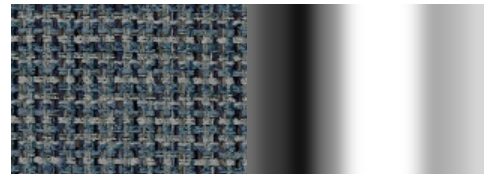

Substitution Requests Accepted: Yes

Note: Image(s) may not depict exact product or finishes, see item options.



Sheet Name
Furniture Specifications
Project
FLINT PUBLIC LIBRARY RENOVATION
1026 E. Kearsley St.,
Flint, MI 48503

OPN Project No. **17215000**
Sheet Issue Date **4/28/2021**
Section Number **24.0**
Item Code **O-10**

Item Information

Section Number 24.0
Item Code S-1
Manufacturer Knoll
Model Rockwell Unscripted Media Cart
Model Number USATVM686025DC
Dimensions --
Description Media cart with double sided storage, white board, and TV mount.
Special Instructions --

Item Options

Paint Finish 114 - Folkstone Grey
Cabinet Case Finish 118 - Bright White
Cabinet Edgeband Finish 118 - Bright White
Door Finish 118 - Bright White
Door Edgeband Finish 118 - Bright White

Item Locations/Counts

ROOM NUMBER	ROOM NAME	COUNT
309	DIGITAL MEDIA/ MAKER LAB	1
COUNT TOTAL		1



Substitution Requests Accepted: Yes

Note: Image(s) may not depict exact product or finishes, see item options.



Sheet Name
Furniture Specifications
Project
FLINT PUBLIC LIBRARY RENOVATION
1026 E. Kearsley St.,
Flint, MI 48503

OPN Project No. **17215000**
Sheet Issue Date **4/28/2021**
Section Number **24.0**
Item Code **S-1**

Item Information

Section Number 25.0
Item Code B-4
Manufacturer Landscape Forms
Model Palisade Bench
Model Number Palisade
Dimensions 96"W. X 19.5"D. X 18"H.
Description Exterior backless wood bench.
Special Instructions --

Item Options

Length 96"
Wood Type Redwood
Mounting Type Freestanding

Item Locations/Counts

ROOM NUMBER	ROOM NAME	COUNT
MAIN LEVEL		
237	PATIO	4
COUNT TOTAL		4



Substitution Requests Accepted: Yes

Note: Image(s) may not depict exact product or finishes, see item options.



Sheet Name
Furniture Specifications
Project
FLINT PUBLIC LIBRARY RENOVATION
1026 E. Kearsley St.,
Flint, MI 48503

OPN Project No. **17215000**
Sheet Issue Date **4/28/2021**
Section Number **25.0**
Item Code **B-4**

Item Information

Section Number 25.0
Item Code TA-23
Manufacturer Landscape Forms
Model Carousel 4 Seat
Model Number Carousel - Dining Height
Dimensions 90"Dia. X 33"H.
Description Metal outdoor table with 4 attached seats.
Special Instructions --

Item Options

Height Dining
Seat Type Hoop
Seat Units 4
Tabletop Material Steelhead Perforated
Umbrella Hole Yes
Powdercoat Color White
Mounting Style Surface Mount

Item Locations/Counts

ROOM NUMBER	ROOM NAME	COUNT
MAIN LEVEL		
237	PATIO	2
COUNT TOTAL		2

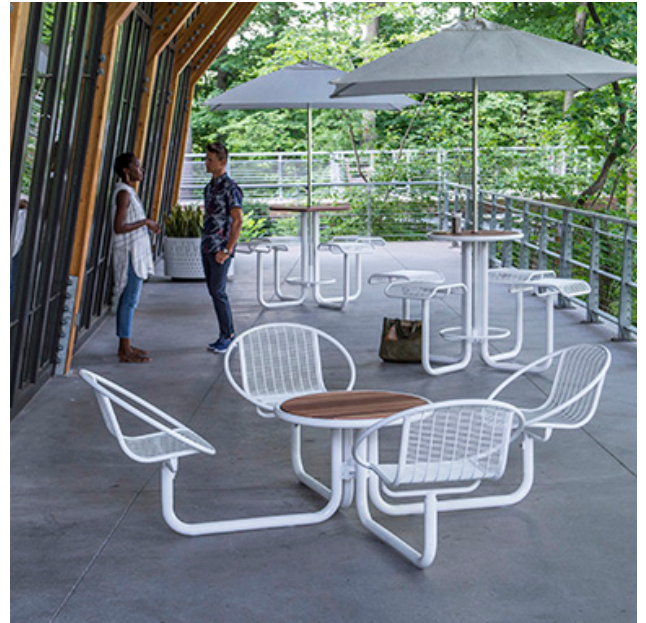

Substitution Requests Accepted: Yes

Note: Image(s) may not depict exact product or finishes, see item options.



Sheet Name
Furniture Specifications
Project
FLINT PUBLIC LIBRARY RENOVATION
1026 E. Kearsley St.,
Flint, MI 48503

OPN Project No. **17215000**
Sheet Issue Date **4/28/2021**
Section Number **25.0**
Item Code **TA-23**

Item Information

Section Number 25.0
Item Code TA-24
Manufacturer Landscape Forms
Model Carousel 3 Seat
Model Number Carousel - Dining Height
Dimensions 90"Dia. X 33"H.
Description Metal outdoor table with 3 attached seats.
Special Instructions --

Item Options

Height Dining
Seat Type Hoop
Seat Units 3
Tabletop Material Steelhead Perforated
Umbrella Hole Yes
Powdercoat Color White
Mounting Style Surface Mount

Item Locations/Counts

ROOM NUMBER	ROOM NAME	COUNT
MAIN LEVEL		
237	PATIO	2
COUNT TOTAL		2

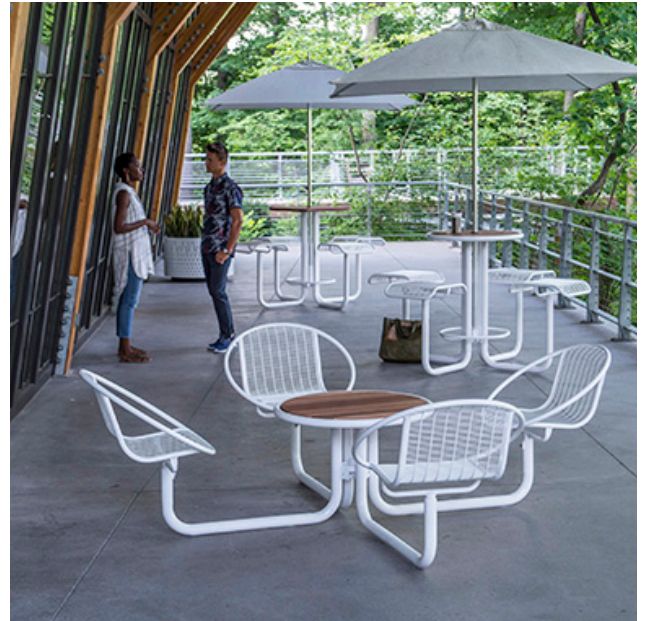

Substitution Requests Accepted: Yes

Note: Image(s) may not depict exact product or finishes, see item options.



Sheet Name
Furniture Specifications
Project
FLINT PUBLIC LIBRARY RENOVATION
1026 E. Kearsley St.,
Flint, MI 48503

OPN Project No. **17215000**
Sheet Issue Date **4/28/2021**
Section Number **25.0**
Item Code **TA-24**

Item Information

Section Number 26.0
Item Code CH-2
Manufacturer Leland
Model Amadeus Chair
Model Number AMSW-PO
Dimensions --
Description Café chair with polypropelene seat and wood legs.
Special Instructions --

Item Options

Shell Color WT - White
Wood Base Finish 25 - Graphite

Item Locations/Counts

ROOM NUMBER	ROOM NAME	COUNT
MAIN LEVEL		
220	SNACK AREA	4
COUNT TOTAL		4



Substitution Requests Accepted: Yes

Note: Image(s) may not depict exact product or finishes, see item options.



Sheet Name
Furniture Specifications
Project
FLINT PUBLIC LIBRARY RENOVATION
1026 E. Kearsley St.,
Flint, MI 48503

OPN Project No. **17215000**
Sheet Issue Date **4/28/2021**
Section Number **26.0**
Item Code **CH-2**

Item Information

Section Number 26.0
Item Code CH-4
Manufacturer Leland - Freshcoast
Model Manitou Children's Chair
Model Number MTC-SH16
Dimensions --
Description Children's computer chair - wood back/seat chair with 4 leg metal base. Slant shell shape. Snake shell art.
Special Instructions --

Item Options

Seat Height SH16 - 16"
Shell Style SL - Slant
Shell Color 18M - Ink II
Shell Art F001 - Snake
Base Finish ST - Sterling

Item Locations/Counts

ROOM NUMBER	ROOM NAME	COUNT
MAIN LEVEL		
212	CHILDREN'S COLLECTION	1
COUNT TOTAL		1

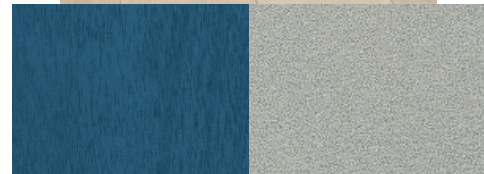

Substitution Requests Accepted: Yes

Note: Image(s) may not depict exact product or finishes, see item options.

Item Information

Section Number 26.0
Item Code CH-5
Manufacturer Leland - Freshcoast
Model Manitou Children's Chair
Model Number MTC-SH16
Dimensions --
Description Children's computer chair - wood back/seat chair with 4 leg metal base. Slant shell shape. Lizard shell art.
Special Instructions --

Item Options

Seat Height SH16 - 16"
Shell Style SL - Slant
Shell Color 18M - Ink II
Shell Art F002 - Lizard
Base Finish ST - Sterling

Item Locations/Counts

ROOM NUMBER	ROOM NAME	COUNT
MAIN LEVEL		
212	CHILDREN'S COLLECTION	1
COUNT TOTAL		1

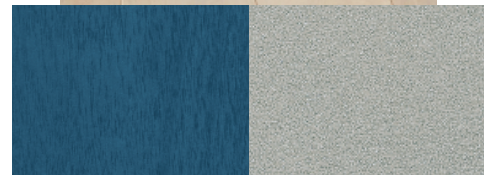

Substitution Requests Accepted: Yes

Note: Image(s) may not depict exact product or finishes, see item options.



Sheet Name
Furniture Specifications
Project
FLINT PUBLIC LIBRARY RENOVATION
1026 E. Kearsley St.,
Flint, MI 48503

OPN Project No. **17215000**
Sheet Issue Date **4/28/2021**
Section Number **26.0**
Item Code **CH-5**

Item Information

Section Number 26.0
Item Code CH-6
Manufacturer Leland - Freshcoast
Model Manitou Children's Chair
Model Number MTC-SH16
Dimensions --
Description Children's computer chair - wood back/seat chair with 4 leg metal base. Slant shell shape. Tree frog shell art.
Special Instructions --

Item Options

Seat Height SH16 - 16"
Shell Style SL - Slant
Shell Color 18M - Ink II
Shell Art F003 - Tree Frog
Base Finish ST - Sterling

Item Locations/Counts

ROOM NUMBER	ROOM NAME	COUNT
MAIN LEVEL		
212	CHILDREN'S COLLECTION	1
COUNT TOTAL		1

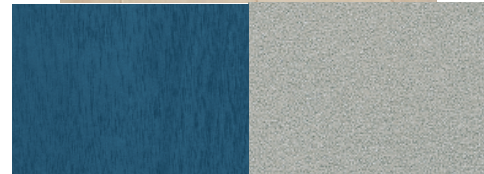

tree frog
(F003)

Substitution Requests Accepted: Yes

Note: Image(s) may not depict exact product or finishes, see item options.



Sheet Name
Furniture Specifications
Project
FLINT PUBLIC LIBRARY RENOVATION
1026 E. Kearsley St.,
Flint, MI 48503

OPN Project No. **17215000**
Sheet Issue Date **4/28/2021**
Section Number **26.0**
Item Code **CH-6**

Item Information

Section Number 26.0
Item Code CH-7
Manufacturer Leland - Freshcoast
Model Manitou Children's Chair
Model Number MTC-SH16
Dimensions --
Description Children's computer chair - wood back/seat chair with 4 leg metal base. Slant shell shape. Turtle shell art.
Special Instructions --

Item Options

Seat Height SH16 - 16"
Shell Style SL - Slant
Shell Color 18M - Ink II
Shell Art F004 - Turtle
Base Finish ST - Sterling

Item Locations/Counts

ROOM NUMBER	ROOM NAME	COUNT
MAIN LEVEL		
212	CHILDREN'S COLLECTION	1
COUNT TOTAL		1

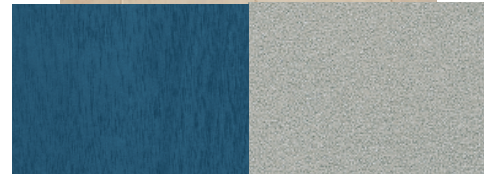

turtle
(F004)

Substitution Requests Accepted: Yes

Note: Image(s) may not depict exact product or finishes, see item options.



Sheet Name
Furniture Specifications
Project
FLINT PUBLIC LIBRARY RENOVATION
1026 E. Kearsley St.,
Flint, MI 48503

OPN Project No. **17215000**
Sheet Issue Date **4/28/2021**
Section Number **26.0**
Item Code **CH-7**

Item Information

Section Number 26.0
Item Code CH-8
Manufacturer Leland - Freshcoast
Model Manitou Children's Chair
Model Number MTC-SH16
Dimensions --
Description Children's computer chair - wood back/seat chair with 4 leg metal base. Tilt shell shape. Rhinoceros shell art.
Special Instructions --

Item Options

Seat Height SH16 - 16"
Shell Style TT - Tilt
Shell Color 18M - Ink II
Shell Art F005 - Rhinoceros
Base Finish ST - Sterling

Item Locations/Counts

ROOM NUMBER	ROOM NAME	COUNT
MAIN LEVEL		
212	CHILDREN'S COLLECTION	1
COUNT TOTAL		1



Substitution Requests Accepted: Yes

Note: Image(s) may not depict exact product or finishes, see item options.



Sheet Name
Furniture Specifications
Project
FLINT PUBLIC LIBRARY RENOVATION
1026 E. Kearsley St.,
Flint, MI 48503

OPN Project No. **17215000**
Sheet Issue Date **4/28/2021**
Section Number **26.0**
Item Code **CH-8**

Item Information

Section Number 26.0
Item Code CH-9
Manufacturer Leland - Freshcoast
Model Manitou Children's Chair
Model Number MTC-SH16
Dimensions --
Description Children's computer chair - wood back/seat chair with 4 leg metal base. Tilt shell shape. Elephant shell art.
Special Instructions --

Item Options

Seat Height SH16 - 16"
Shell Style TT - Tilt
Shell Color 18M - Ink II
Shell Art F006 - Elephant
Base Finish ST - Sterling

Item Locations/Counts

ROOM NUMBER	ROOM NAME	COUNT
MAIN LEVEL		
212	CHILDREN'S COLLECTION	1
COUNT TOTAL		1



Substitution Requests Accepted: Yes

Note: Image(s) may not depict exact product or finishes, see item options.



Sheet Name
Furniture Specifications
Project
FLINT PUBLIC LIBRARY RENOVATION
1026 E. Kearsley St.,
Flint, MI 48503

OPN Project No. **17215000**
Sheet Issue Date **4/28/2021**
Section Number **26.0**
Item Code **CH-9**

Item Information

Section Number 26.0
Item Code CH-10
Manufacturer Leland - Freshcoast
Model Manitou Children's Chair
Model Number MTC-SH16
Dimensions --
Description Children's computer chair - wood back/seat chair with 4 leg metal base. Tilt shell shape. Lioness shell art.
Special Instructions --

Item Options

Seat Height SH16 - 16"
Shell Style TT - Tilt
Shell Color 18M - Ink II
Shell Art F007 - Lioness
Base Finish ST - Sterling

Item Locations/Counts

ROOM NUMBER	ROOM NAME	COUNT
MAIN LEVEL		
212	CHILDREN'S COLLECTION	1
COUNT TOTAL		1



Substitution Requests Accepted: Yes

Note: Image(s) may not depict exact product or finishes, see item options.

Item Information

Section Number 26.0
Item Code CH-11
Manufacturer Leland - Freshcoast
Model Manitou Children's Chair
Model Number MTC-SH16
Dimensions --
Description Children's computer chair - wood back/seat chair with 4 leg metal base. Tilt shell shape. Giraffe shell art.
Special Instructions --

Item Options

Seat Height SH16 - 16"
Shell Style TT - Tilt
Shell Color 18M - Ink II
Shell Art F009 - Giraffe
Base Finish ST - Sterling

Item Locations/Counts

ROOM NUMBER	ROOM NAME	COUNT
MAIN LEVEL		
212	CHILDREN'S COLLECTION	1
COUNT TOTAL		1

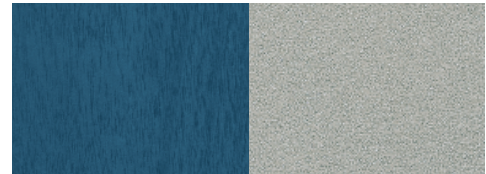

Substitution Requests Accepted: Yes

Note: Image(s) may not depict exact product or finishes, see item options.



Sheet Name
Furniture Specifications
Project
FLINT PUBLIC LIBRARY RENOVATION
1026 E. Kearsley St.,
Flint, MI 48503

OPN Project No. **17215000**
Sheet Issue Date **4/28/2021**
Section Number **26.0**
Item Code **CH-11**

Item Information

Section Number 26.0
Item Code ST-3
Manufacturer Leland
Model Amadeus Stool
Model Number AMBW-PO
Dimensions --
Description Bar height stool with polypropelene seat and stained wood base.
Special Instructions --

Item Options

Shell Color IB - Ice Blue
Wood Base Finish 47M - Ice Blue

Item Locations/Counts

ROOM NUMBER	ROOM NAME	COUNT
MAIN LEVEL		
209	YOUNG ADULT	6
COUNT TOTAL		6



Substitution Requests Accepted: Yes

Note: Image(s) may not depict exact product or finishes, see item options.

Item Information

Section Number 27.0
Item Code TA-26
Manufacturer Magnuson Group
Model Celes Occasional Table
Model Number CELES-M
Dimensions 19.5"Dia. X 13.75"H.
Description Painted aluminum nesting tables.
Special Instructions --

Item Options

Size M
Color White

Item Locations/Counts

ROOM NUMBER	ROOM NAME	COUNT
UPPER LEVEL		
303	UNCONFERENCE ROOM	1
COUNT TOTAL		1



Substitution Requests Accepted: Yes

Note: Image(s) may not depict exact product or finishes, see item options.



Sheet Name
Furniture Specifications
Project
FLINT PUBLIC LIBRARY RENOVATION
1026 E. Kearsley St.,
Flint, MI 48503

OPN Project No. **17215000**
Sheet Issue Date **4/28/2021**
Section Number **27.0**
Item Code **TA-26**

Item Information

Section Number 27.0
Item Code TA-27
Manufacturer Magnuson Group
Model Celes Occasional Table
Model Number CELES-L
Dimensions 19.5"Dia. X 15.75"H.
Description Painted aluminum nesting tables.
Special Instructions --

Item Options

Size L
Color White

Item Locations/Counts

ROOM NUMBER	ROOM NAME	COUNT
UPPER LEVEL		
303	UNCONFERENCE ROOM	4
COUNT TOTAL		4



Substitution Requests Accepted: Yes

Note: Image(s) may not depict exact product or finishes, see item options.



Sheet Name
Furniture Specifications
Project
FLINT PUBLIC LIBRARY RENOVATION
1026 E. Kearsley St.,
Flint, MI 48503

OPN Project No. **17215000**
Sheet Issue Date **4/28/2021**
Section Number **27.0**
Item Code **TA-27**

Item Information

Section Number 27.0
Item Code TA-28
Manufacturer Magnuson Group
Model Celes Occasional Table
Model Number CELES-XL
Dimensions 27.5"Dia. X 18"H.
Description Painted aluminum nesting tables.
Special Instructions --

Item Options

Size XL
Color White

Item Locations/Counts

ROOM NUMBER	ROOM NAME	COUNT
UPPER LEVEL		
303	UNCONFERENCE ROOM	1
COUNT TOTAL		1



Substitution Requests Accepted: Yes

Note: Image(s) may not depict exact product or finishes, see item options.



Sheet Name
Furniture Specifications
Project
FLINT PUBLIC LIBRARY RENOVATION
1026 E. Kearsley St.,
Flint, MI 48503

OPN Project No. **17215000**
Sheet Issue Date **4/28/2021**
Section Number **27.0**
Item Code **TA-28**

Item Information

Section Number 28.0
Item Code TA-19
Manufacturer Martin Bratrud
Model Lutta Counter Height Table
Model Number 801-96EB
Dimensions 96"W. X 42"D X 36"H.
Description Counter height table with solid surface top, metal base, and power integration.
Special Instructions Coordinate surface mount power location with designer.

Item Options

Corian Top Color GW - Glacier White
Metal Base Finish SSS - Satin Stainless Steel
Power Option
Power Receptacle Byrne - Mini-Tap - Silver, Powdercoat
Quantity 2

Item Locations/Counts

ROOM NUMBER	ROOM NAME	COUNT
MAIN LEVEL		
202	ADULT - FICTION	3
UPPER LEVEL		
305	CAFE	1
327	READING ROOM	1
COUNT TOTAL		5

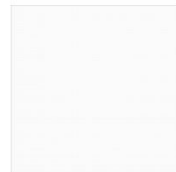

GW
Glacier White



SSS
Satin Stainless Steel



Substitution Requests Accepted: Yes

Note: Image(s) may not depict exact product or finishes, see item options.



Sheet Name
Furniture Specifications
Project
FLINT PUBLIC LIBRARY RENOVATION
1026 E. Kearsley St.,
Flint, MI 48503

OPN Project No. **17215000**
Sheet Issue Date **4/28/2021**
Section Number **28.0**
Item Code **TA-19**

Item Information

Section Number 29.0
Item Code LC-30
Manufacturer National
Model Grin Sled Base Lounge Chair
Model Number N49GMND1
Dimensions --
Description Upholstered lounge chair with metal sled base.
Special Instructions --

Item Options

Fabric Carnegie - Hide - 20
Base Finish 497 - Polished

Item Locations/Counts

ROOM NUMBER	ROOM NAME	COUNT
LOWER LEVEL		
116	BREAK ROOM	2
COUNT TOTAL		2

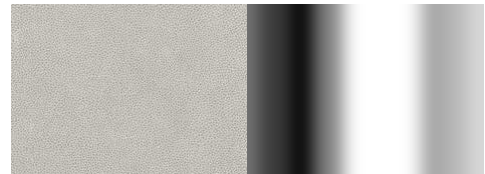

Substitution Requests Accepted: Yes

Note: Image(s) may not depict exact product or finishes, see item options.

Item Information

Section Number 30.0
Item Code S-2
Manufacturer Nucraft
Model High Tech Lectern
Model Number AVCL-2845-CP-PE
Dimensions --
Description Lectern with casters, pull out shelf, microphone, light, and power/data module.
Special Instructions --

Item Options

Top Finish 459-58 - Brite White
Edge Finish R01 - Whitecap
Case Finish S8004 - Cloud
Metal Finish A8006 - Foil
Light Code LT - Light with Dimmer
Microphone Code MC - Gooseneck Microphone
Slide Out Shelf Code SS - Slide-Out Shelf (Right Side Only)

Item Locations/Counts

ROOM NUMBER	ROOM NAME	COUNT
MAIN LEVEL		
234	COMMUNITY ROOM	1
UPPER LEVEL		
324	STORAGE	1
326	MEETING ROOM	1
COUNT TOTAL		3



Substitution Requests Accepted: Yes

Note: Image(s) may not depict exact product or finishes, see item options.

Item Information

Section Number 31.0
Item Code B-2
Manufacturer OFS
Model Rowen Bench
Model Number 83249.0
Dimensions --
Description Upholstered bench with center table.
Special Instructions *Add Nano-Tex® to HBF Grateful Grid* Contact HBF Textiles for information on lead time and additional yardage necessary for shrinkage.

Item Options

Leg MAL - Metal
Leg Finish A2J - Polished Chrome
Power X9 - None
Table Finish - SS MWS - Modern White
Fabric - Seat HBF - Grateful Grid - 44 Fire
Fabric - Bottom Surround HBF - Abito - 90 Arco

Item Locations/Counts

ROOM NUMBER	ROOM NAME	COUNT
MAIN LEVEL		
202	ADULT - FICTION	5
COUNT TOTAL		5



Substitution Requests Accepted: Yes

Note: Image(s) may not depict exact product or finishes, see item options.



Sheet Name
Furniture Specifications
Project
FLINT PUBLIC LIBRARY RENOVATION
1026 E. Kearsley St.,
Flint, MI 48503

OPN Project No. **17215000**
Sheet Issue Date **4/28/2021**
Section Number **31.0**
Item Code **B-2**

Item Information

Section Number 31.0
Item Code B-3
Manufacturer OFS
Model Rowen Bench
Model Number 83249.0
Dimensions --
Description Upholstered bench with center table.
Special Instructions *Add Nano-Tex® | Moisture Barrier to HBF Picnic Plaid*
Contact HBF Textiles for information on lead time and additional yardage necessary for shrinkage.

Item Options

Leg MAL - Metal
Leg Finish A2J - Polished Chrome
Power X9 - None
Table Finish - SS MWS - Modern White
Fabric - Seat HBF - Picnic Plaid - 44 Campfire
Fabric - Bottom Surround Architex - Wardrobe - Terra

Item Locations/Counts

ROOM NUMBER	ROOM NAME	COUNT
UPPER LEVEL		
301	LOBBY	3
302	ADULT - NON FICTION	2
COUNT TOTAL		5

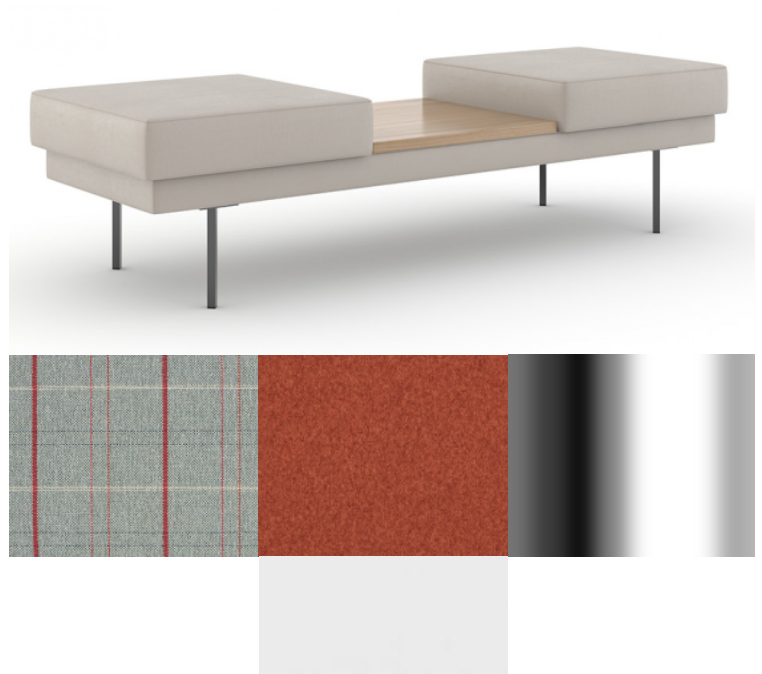

Substitution Requests Accepted: Yes

Note: Image(s) may not depict exact product or finishes, see item options.



Sheet Name
Furniture Specifications
Project
FLINT PUBLIC LIBRARY RENOVATION
1026 E. Kearsley St.,
Flint, MI 48503

OPN Project No. **17215000**
Sheet Issue Date **4/28/2021**
Section Number **31.0**
Item Code **B-3**

Item Information

Section Number 31.0
Item Code LC-22
Manufacturer OFS
Model Evergreen Lounge Chair
Model Number 680-1
Dimensions --
Description Upholstered lounge seat with wood legs.
Special Instructions --

Item Options

Leg Finish MNW - Root
Arm Cap Finish X9 - None
Ferrules X9 - None
Fabric HBF Textiles - Abito - 80 Garda

Item Locations/Counts

ROOM NUMBER	ROOM NAME	COUNT
UPPER LEVEL		
302	ADULT - NON FICTION	8
327	READING ROOM	4
COUNT TOTAL		12

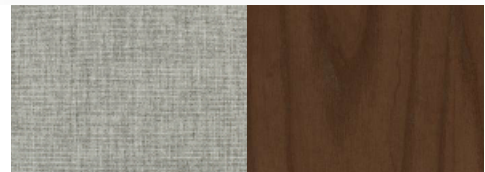

Substitution Requests Accepted: Yes

Note: Image(s) may not depict exact product or finishes, see item options.



Sheet Name
Furniture Specifications
Project
FLINT PUBLIC LIBRARY RENOVATION
1026 E. Kearsley St.,
Flint, MI 48503

OPN Project No. **17215000**
Sheet Issue Date **4/28/2021**
Section Number **31.0**
Item Code **LC-22**

Item Information

Section Number 31.0
Item Code LC-23
Manufacturer OFS
Model Evergreen Lounge Chair
Model Number 680-1
Dimensions --
Description Upholstered lounge seat with wood legs.
Special Instructions --

Item Options

Leg Finish MNW - Root
Arm Cap Finish X9 - None
Ferrules X9 - None
Fabric Wolf Gordon Tallinn - Nightfall

Item Locations/Counts

ROOM NUMBER	ROOM NAME	COUNT
MAIN LEVEL		
202	ADULT - FICTION	8
COUNT TOTAL		8

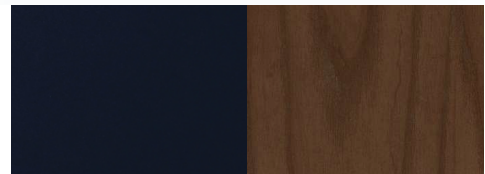

Substitution Requests Accepted: Yes

Note: Image(s) may not depict exact product or finishes, see item options.



Sheet Name
Furniture Specifications
Project
FLINT PUBLIC LIBRARY RENOVATION
1026 E. Kearsley St.,
Flint, MI 48503

OPN Project No. **17215000**
Sheet Issue Date **4/28/2021**
Section Number **31.0**
Item Code **LC-23**

Item Information

Section Number 31.0
Item Code LC-24
Manufacturer OFS
Model Mention Rocker
Model Number F81046-C87
Dimensions --
Description Upholstered lounge chair with wood rocker base.
Special Instructions *Add Nano-Tex® | Moisture Barrier* Contact HBF Textiles for information on lead time and additional yardage necessary for shrinkage.

Item Options

Base C8Z - Wood Rocker
Wood Finish MNW - Root
Fabric HBF Textiles - Picnic Plaid 1029 - 56 Summertime

Item Locations/Counts

ROOM NUMBER	ROOM NAME	COUNT
MAIN LEVEL		
202	ADULT - FICTION	4
COUNT TOTAL		4

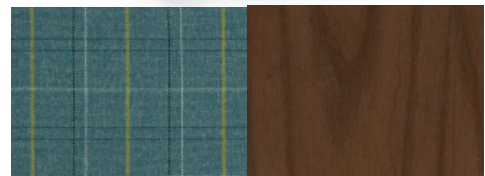

Substitution Requests Accepted: Yes

Note: Image(s) may not depict exact product or finishes, see item options.



Sheet Name
Furniture Specifications
Project
FLINT PUBLIC LIBRARY RENOVATION
1026 E. Kearsley St.,
Flint, MI 48503

OPN Project No. **17215000**
Sheet Issue Date **4/28/2021**
Section Number **31.0**
Item Code **LC-24**

Item Information

Section Number 31.0
Item Code LC-25
Manufacturer OFS
Model Mention Rocker
Model Number F81046-C87
Dimensions --
Description Upholstered lounge chair with wood rocker base.
Special Instructions --

Item Options

Base C8Z - Wood Rocker
Wood Finish MNW - Root
Fabric Architex - Adlon - Orange

Item Locations/Counts

ROOM NUMBER	ROOM NAME	COUNT
UPPER LEVEL		
303	UNCONFERENCE ROOM	1
COUNT TOTAL		1



Substitution Requests Accepted: Yes

Note: Image(s) may not depict exact product or finishes, see item options.



Sheet Name
Furniture Specifications
Project
FLINT PUBLIC LIBRARY RENOVATION
1026 E. Kearsley St.,
Flint, MI 48503

OPN Project No. **17215000**
Sheet Issue Date **4/28/2021**
Section Number **31.0**
Item Code **LC-25**

Item Information

Section Number 31.0
Item Code LC-26
Manufacturer OFS
Model Mention Rocker
Model Number F81046-C87
Dimensions --
Description Upholstered lounge chair with wood rocker base.
Special Instructions --

Item Options

Base C8Z - Wood Rocker
Wood Finish MNW - Root
Fabric Sina Pearson - Cut Circles - Ivory/Lemon

Item Locations/Counts

ROOM NUMBER	ROOM NAME	COUNT
MAIN LEVEL		
212	CHILDREN'S COLLECTION	3
COUNT TOTAL		3

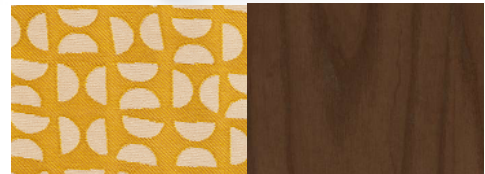

Substitution Requests Accepted: Yes

Note: Image(s) may not depict exact product or finishes, see item options.

Item Information

Section Number 32.0
Item Code LC-27
Manufacturer Paul Brayton
Model Ellary Lounge Chair
Model Number 880-L10
Dimensions --
Description High back upholstered lounge chair with wood base.
Special Instructions *Provide Nanotex + moisture barrier backing*

Item Options

Fabric Paul Brayton - Cirrus - Celestial
Wood Finish WF-22 - Medium Walnut

Item Locations/Counts

ROOM NUMBER	ROOM NAME	COUNT
MAIN LEVEL		
202	ADULT - FICTION	3
UPPER LEVEL		
301	LOBBY	2
302	ADULT - NON FICTION	2
327	READING ROOM	4
COUNT TOTAL		11

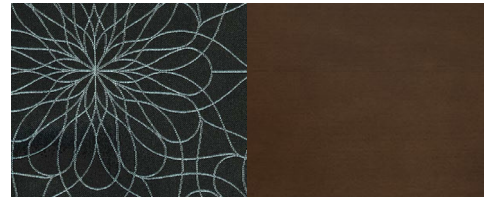

Substitution Requests Accepted: Yes

Note: Image(s) may not depict exact product or finishes, see item options.



Sheet Name
Furniture Specifications
Project
FLINT PUBLIC LIBRARY RENOVATION
1026 E. Kearsley St.,
Flint, MI 48503

OPN Project No. **17215000**
Sheet Issue Date **4/28/2021**
Section Number **32.0**
Item Code **LC-27**

Item Information

Section Number 32.0
Item Code LC-28
Manufacturer Paul Brayton
Model Ellary Lounge Chair
Model Number 880-L10
Dimensions --
Description High back upholstered lounge chair with wood base.
Special Instructions --

Item Options

Fabric Maharam - Apt - 017 Shoreline
Wood Finish WF-22 - Medium Walnut

Item Locations/Counts

ROOM NUMBER	ROOM NAME	COUNT
MAIN LEVEL		
202	ADULT - FICTION	3
UPPER LEVEL		
301	LOBBY	2
302	ADULT - NON FICTION	2
327	READING ROOM	4
COUNT TOTAL		11

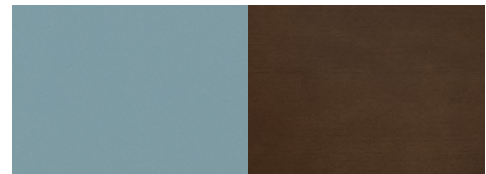

Substitution Requests Accepted: Yes

Note: Image(s) may not depict exact product or finishes, see item options.

Item Information

Section Number 33.0
Item Code A-1
Manufacturer Peter Pepper
Model SRT Tall Recycling Station - Dual Stream
Model Number SRT
Dimensions 30"W. X 12"D. X 27"H.
Description Waste and recycling center.
Special Instructions --

Item Options

Exterior Finish Aluminum Metallic
Interior Finish Aluminum Metallic
Decal Color Graphite

Item Locations/Counts

ROOM NUMBER	ROOM NAME	COUNT
LOWER LEVEL		
132	LOCAL HISTORY & GENEALOGY	1
MAIN LEVEL		
202	ADULT - FICTION	3
212	CHILDREN'S COLLECTION	2
UPPER LEVEL		
301	LOBBY	1
302	ADULT - NON FICTION	1
306	PUBLIC ACCESS COMPUTERS	2
316	CORRIDOR	1
326	MEETING ROOM	1
COUNT TOTAL		12



Aluminum Metallic

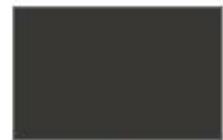

Graphite

Substitution Requests Accepted: Yes

Note: Image(s) may not depict exact product or finishes, see item options.



Sheet Name
Furniture Specifications
Project
FLINT PUBLIC LIBRARY RENOVATION
1026 E. Kearsley St.,
Flint, MI 48503

OPN Project No. **17215000**
Sheet Issue Date **4/28/2021**
Section Number **33.0**
Item Code **A-1**

Item Information

Section Number 34.0
Item Code S-12
Manufacturer Russ Bassett
Model Microfilm Storage Cabinet
Model Number PM4-8W
Dimensions 36"W. X 24"D. X 38"H.
Description Powder coated heavy gauge media storage drawers. Eight drawer lateral roll film storage cabinet.
Special Instructions --

Item Options

N/A N/A

Item Locations/Counts

ROOM NUMBER	ROOM NAME	COUNT
LOWER LEVEL		
134	SPECIAL COLLECTIONS	6
COUNT TOTAL		6



Substitution Requests Accepted: Yes

Note: Image(s) may not depict exact product or finishes, see item options.



Sheet Name
Furniture Specifications
Project
FLINT PUBLIC LIBRARY RENOVATION
1026 E. Kearsley St.,
Flint, MI 48503

OPN Project No. **17215000**
Sheet Issue Date **4/28/2021**
Section Number **34.0**
Item Code **S-12**

Item Information

Section Number 35.0
Item Code LC-31
Manufacturer Sixinch
Model Livv Lounge Chair
Model Number LIVV LOUNGE
Dimensions --
Description Upholstered lounge chair with metal base.
Special Instructions --

Item Options

Fabric C.F. Stinson - Core - Persimmon
Metal Finish Silver

Item Locations/Counts

ROOM NUMBER	ROOM NAME	COUNT
MAIN LEVEL		
212	CHILDREN'S COLLECTION	3
COUNT TOTAL		3



Substitution Requests Accepted: Yes

Note: Image(s) may not depict exact product or finishes, see item options.



Sheet Name
Furniture Specifications
Project
FLINT PUBLIC LIBRARY RENOVATION
1026 E. Kearsley St.,
Flint, MI 48503

OPN Project No. **17215000**
Sheet Issue Date **4/28/2021**
Section Number **35.0**
Item Code **LC-31**

Item Information

Section Number 35.0
Item Code OL-1
Manufacturer Sixinch
Model Steen Pouf
Model Number Steen Pouf
Dimensions --
Description Outdoor pouf with FlexPlus coating.
Special Instructions --

Item Options

FlexPlus Color Robins Egg

Item Locations/Counts

ROOM NUMBER	ROOM NAME	COUNT
MAIN LEVEL		
237	PATIO	4
COUNT TOTAL		4



Substitution Requests Accepted: Yes

Note: Image(s) may not depict exact product or finishes, see item options.



Sheet Name
Furniture Specifications
Project
FLINT PUBLIC LIBRARY RENOVATION
1026 E. Kearsley St.,
Flint, MI 48503

OPN Project No. **17215000**
Sheet Issue Date **4/28/2021**
Section Number **35.0**
Item Code **OL-1**

Item Information

Section Number 35.0
Item Code OL-2
Manufacturer Sixinch
Model Steen Sofa
Model Number Steen Sofa
Dimensions --
Description Outdoor sofa with FlexPlus coating.
Special Instructions --

Item Options

FlexPlus Color Smoke

Item Locations/Counts

ROOM NUMBER	ROOM NAME	COUNT
MAIN LEVEL		
237	PATIO	2
COUNT TOTAL		2



Substitution Requests Accepted: Yes

Note: Image(s) may not depict exact product or finishes, see item options.



Sheet Name
Furniture Specifications
Project
FLINT PUBLIC LIBRARY RENOVATION
1026 E. Kearsley St.,
Flint, MI 48503

OPN Project No. **17215000**
Sheet Issue Date **4/28/2021**
Section Number **35.0**
Item Code **OL-2**

Item Information

Section Number 35.0
Item Code OL-3
Manufacturer Sixinch
Model Steen Table
Model Number Steen Table
Dimensions --
Description Outdoor "table" with FlexPlus coating.
Special Instructions --

Item Options

FlexPlus Color Anthracite

Item Locations/Counts

ROOM NUMBER	ROOM NAME	COUNT
MAIN LEVEL		
237	PATIO	1
COUNT TOTAL		1



Substitution Requests Accepted: Yes

Note: Image(s) may not depict exact product or finishes, see item options.



Sheet Name
Furniture Specifications
Project
FLINT PUBLIC LIBRARY RENOVATION
1026 E. Kearsley St.,
Flint, MI 48503

OPN Project No. **17215000**
Sheet Issue Date **4/28/2021**
Section Number **35.0**
Item Code **OL-3**

Item Information

Section Number 36.0
Item Code TA-21
Manufacturer Source
Model LT Laptop Table
Model Number 555-COR
Dimensions --
Description Laptop table with Corian top.
Special Instructions --

Item Options

Corian Color COR Corian - Glacier White
Metal Finish SCR - Soft Chrome

Item Locations/Counts

ROOM NUMBER	ROOM NAME	COUNT
LOWER LEVEL		
102	PROJECT ROOM	3
MAIN LEVEL		
202	ADULT - FICTION	8
203	STUDY ROOM	1
208	STUDY ROOM	1
209	YOUNG ADULT	8
COUNT TOTAL		21



Substitution Requests Accepted: Yes

Note: Image(s) may not depict exact product or finishes, see item options.



Sheet Name
Furniture Specifications
Project
FLINT PUBLIC LIBRARY RENOVATION
1026 E. Kearsley St.,
Flint, MI 48503

OPN Project No. **17215000**
Sheet Issue Date **4/28/2021**
Section Number **36.0**
Item Code **TA-21**

Item Information

Section Number 37.0
 Item Code O-11
 Manufacturer Studio TK
 Model Qui Small Ottoman - Upholstered Mid Panel
 Model Number STBA-1
 Dimensions 25.5" Dia.
 Description Small upholstered ottoman.
 Special Instructions --

Item Options

Top Fabric Wolf Gordon - East Village - Citrine
 Mid Fabric Pallas - Aphrodite - Black Tide
 Base Fabric Wolf Gordon - East Village - Citrine
 Thread Finish TC03 - Black

Item Locations/Counts

ROOM NUMBER	ROOM NAME	COUNT
MAIN LEVEL		
212	CHILDREN'S COLLECTION	2
COUNT TOTAL		2



Black [TC03]



Substitution Requests Accepted: Yes

Note: Image(s) may not depict exact product or finishes, see item options.



Sheet Name
Furniture Specifications
 Project
FLINT PUBLIC LIBRARY RENOVATION
 1026 E. Kearsley St.,
 Flint, MI 48503

OPN Project No. **17215000**
 Sheet Issue Date **4/28/2021**
 Section Number **37.0**
 Item Code **O-11**

Item Information

Section Number 37.0
 Item Code O-12
 Manufacturer Studio TK
 Model Qui Small Ottoman - Upholstered Mid Panel
 Model Number STBA-1
 Dimensions 25.5" Dia.
 Description Small upholstered ottoman.
 Special Instructions --

Item Options

Top Fabric Wolf Gordon - East Village - Grape
 Mid Fabric Pallas - Aphrodite - Black Tide
 Base Fabric Wolf Gordon - East Village - Grape
 Thread Finish TC03 - Black

Item Locations/Counts

ROOM NUMBER	ROOM NAME	COUNT
MAIN LEVEL		
212	CHILDREN'S COLLECTION	2
COUNT TOTAL		2



Black [TC03]



Substitution Requests Accepted: Yes

Note: Image(s) may not depict exact product or finishes, see item options.



Sheet Name
Furniture Specifications
 Project
FLINT PUBLIC LIBRARY RENOVATION
 1026 E. Kearsley St.,
 Flint, MI 48503

OPN Project No. **17215000**
 Sheet Issue Date **4/28/2021**
 Section Number **37.0**
 Item Code **O-12**

Item Information

Section Number 37.0
 Item Code O-13
 Manufacturer Studio TK
 Model Qui Small Ottoman - Upholstered Mid Panel
 Model Number STBA-1
 Dimensions 25.5" Dia.
 Description Small upholstered ottoman.
 Special Instructions --

Item Options

Top Fabric Wolf Gordon - Pelle - Baltic
 Mid Fabric Pallas - Aphrodite - Black Tide
 Base Fabric Wolf Gordon - Pelle - Baltic
 Thread Finish TC03 - Black

Item Locations/Counts

ROOM NUMBER	ROOM NAME	COUNT
MAIN LEVEL		
212	CHILDREN'S COLLECTION	4
COUNT TOTAL		4



Black (TC03)



Substitution Requests Accepted: Yes

Note: Image(s) may not depict exact product or finishes, see item options.



Sheet Name
Furniture Specifications
 Project
FLINT PUBLIC LIBRARY RENOVATION
 1026 E. Kearsley St.,
 Flint, MI 48503

OPN Project No. **17215000**
 Sheet Issue Date **4/28/2021**
 Section Number **37.0**
 Item Code **O-13**

Item Information

Section Number 37.0
Item Code O-14
Manufacturer Studio TK
Model Qui Medium Ottoman - Upholstered Mid Panel Thread Finish
Model Number STBC-3
Dimensions 44.5" Dia.
Description Medium upholstered ottoman.
Special Instructions --

Item Options

Top Fabric Wolf Gordon - East Village - Grape
Mid Fabric Pallas - Aphrodite - Black Tide
Base Fabric Wolf Gordon - East Village - Grape
TC03 - Black

Item Locations/Counts

ROOM NUMBER	ROOM NAME	COUNT
MAIN LEVEL		
212	CHILDREN'S COLLECTION	2
COUNT TOTAL		2



Black [TC03]



Substitution Requests Accepted: Yes

Note: Image(s) may not depict exact product or finishes, see item options.



Sheet Name
Furniture Specifications
Project
FLINT PUBLIC LIBRARY RENOVATION
1026 E. Kearsley St.,
Flint, MI 48503

OPN Project No. **17215000**
Sheet Issue Date **4/28/2021**
Section Number **37.0**
Item Code **O-14**

Item Information

Section Number 37.0
 Item Code O-15
 Manufacturer Studio TK
 Model Qui Large Ottoman - Upholstered Mid Panel
 Model Number STBC-4
 Dimensions 60" Dia.
 Description Large upholstered ottoman.
 Special Instructions --

Item Options

Top Fabric Wolf Gordon - East Village - Citrine
 Mid Fabric Pallas - Aphrodite - Black Tide
 Base Fabric Wolf Gordon - East Village - Citrine
 Thread Finish TC03 - Black

Item Locations/Counts

ROOM NUMBER	ROOM NAME	COUNT
MAIN LEVEL		
212	CHILDREN'S COLLECTION	1
COUNT TOTAL		1



Black [TC03]



Substitution Requests Accepted: Yes

Note: Image(s) may not depict exact product or finishes, see item options.



Sheet Name
Furniture Specifications
 Project
FLINT PUBLIC LIBRARY RENOVATION
 1026 E. Kearsley St.,
 Flint, MI 48503

OPN Project No. **17215000**
 Sheet Issue Date **4/28/2021**
 Section Number **37.0**
 Item Code **O-15**

Item Information

Section Number 38.0
 Item Code RD-1
 Manufacturer Three H
 Model Custom Reception Desk
 Model Number --
 Dimensions --
 Description Laminate reception desk.
 Special Instructions --

Item Options

Worksurface Edge Syle Knife -
 Woodgrain Color W42W - Stream Walnut
 White Color S663 - White

Item Locations/Counts

ROOM NUMBER	ROOM NAME	COUNT
101	STAFF	1
COUNT TOTAL		1

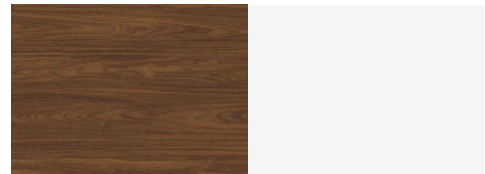
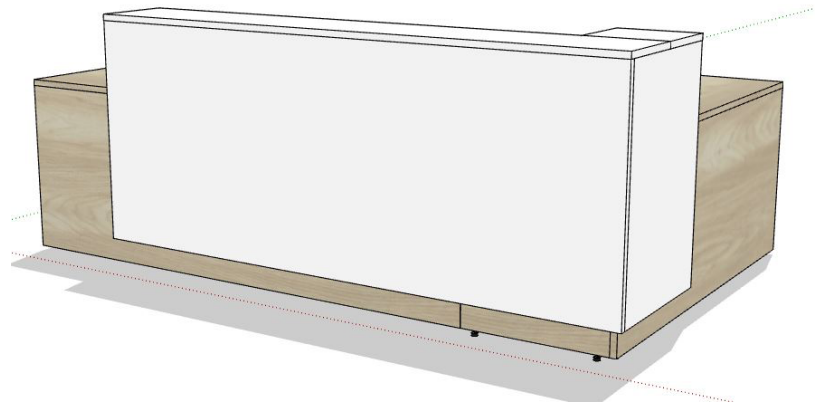

Substitution Requests Accepted: Yes

Note: Image(s) may not depict exact product or finishes, see item options.



Sheet Name
Furniture Specifications
 Project
FLINT PUBLIC LIBRARY RENOVATION
 1026 E. Kearsley St.,
 Flint, MI 48503

OPN Project No. **17215000**
 Sheet Issue Date **4/28/2021**
 Section Number **38.0**
 Item Code **RD-1**

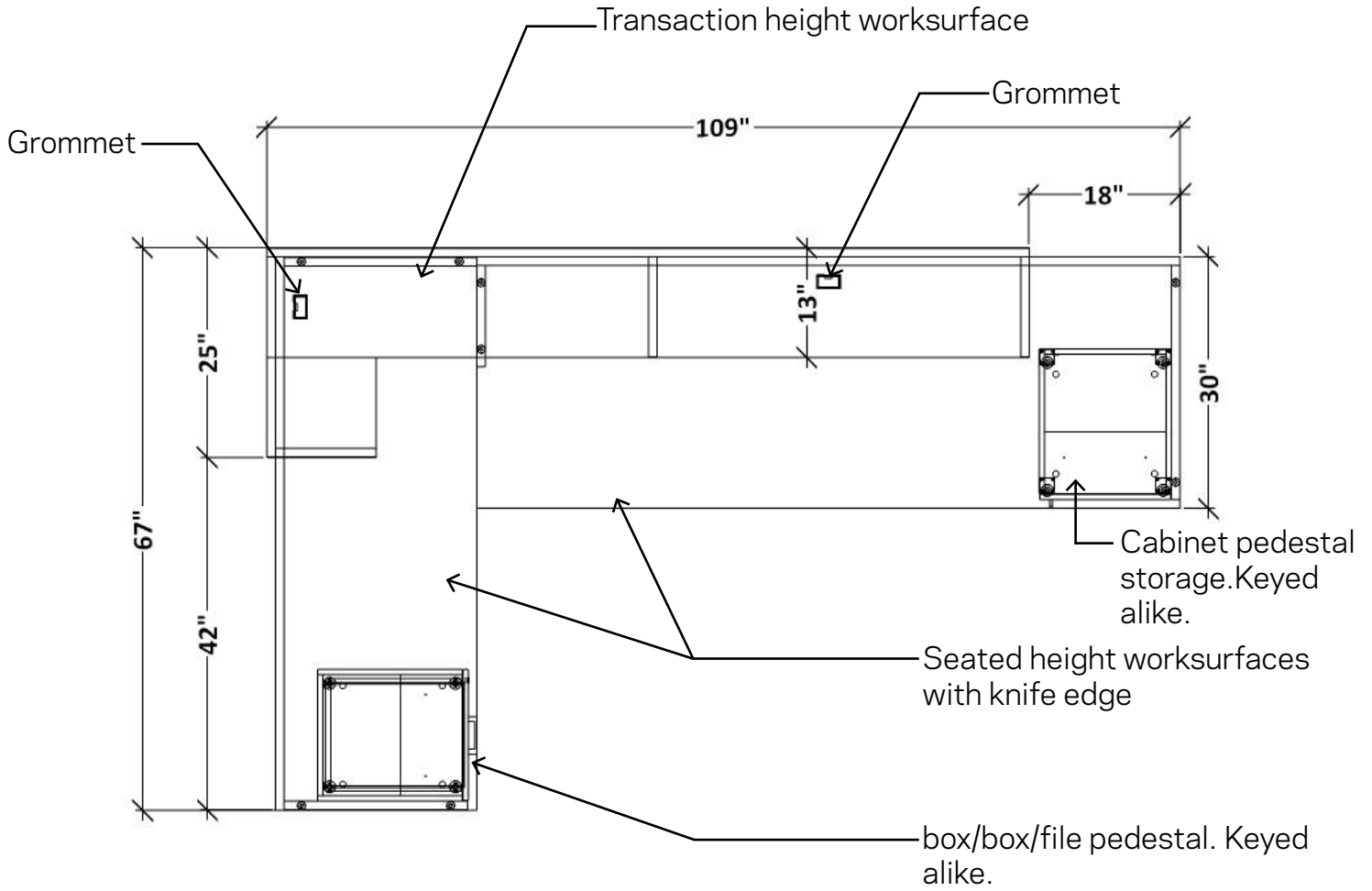

Item Information

Section Number 39.0
Item Code CH-12
Manufacturer TMC Furniture
Model Frody Wood Chair
Model Number N/A
Dimensions 21"W. X 17"D. X 27.5"H.
Description 16" Seat Height
Child's height chair with wood seat/back and metal legs.
Stacks 10 high.
Special Instructions --

Item Options

Seat Color 111 - French Blue
Base Color C-PP11 - Silver
Seat Height 16"

Item Locations/Counts

ROOM NUMBER	ROOM NAME	COUNT
MAIN LEVEL		
222	CHILDREN'S PROGRAM ROOM	30
COUNT TOTAL		30



Substitution Requests Accepted: Yes

Note: Image(s) may not depict exact product or finishes, see item options.

Item Information

Section Number 40.0
Item Code S-8
Manufacturer U-line
Model Chrome Wire Shelving
Model Number H-2947-63
Dimensions 60"W. X 24"D. X 63"H.
Description Wire shelving with 4 shelves. Starter unit.
Special Instructions --

Item Options

N/A N/A

Item Locations/Counts

ROOM NUMBER	ROOM NAME	COUNT
LOWER LEVEL		
112B	SECURED STORAGE	1
113	STORAGE	1
COUNT TOTAL		2



Substitution Requests Accepted: Yes

Note: Image(s) may not depict exact product or finishes, see item options.



Sheet Name
Furniture Specifications
Project
FLINT PUBLIC LIBRARY RENOVATION
1026 E. Kearsley St.,
Flint, MI 48503

OPN Project No. **17215000**
Sheet Issue Date **4/28/2021**
Section Number **40.0**
Item Code **S-8**

Item Information

Section Number 40.0
Item Code S-9
Manufacturer U-line
Model Chrome Wire Shelving
Model Number H-2948-63
Dimensions 72"W. X 24"D. X 63"H.
Description Wire shelving with 4 shelves. Starter unit.
Special Instructions --

Item Options

N/A N/A

Item Locations/Counts

ROOM NUMBER	ROOM NAME	COUNT
LOWER LEVEL		
112B	SECURED STORAGE	2
COUNT TOTAL		2



Substitution Requests Accepted: Yes

Note: Image(s) may not depict exact product or finishes, see item options.



Sheet Name
Furniture Specifications
Project
FLINT PUBLIC LIBRARY RENOVATION
1026 E. Kearsley St.,
Flint, MI 48503

OPN Project No. **17215000**
Sheet Issue Date **4/28/2021**
Section Number **40.0**
Item Code **S-9**

Item Information

Section Number 40.0
Item Code S-10
Manufacturer U-line
Model Chrome Wire Shelving.
Model Number H-2944-63A
Dimensions 24"W. X 24"D. X 63"H.
Description Wire shelving with 4 shelves. Add-on unit.
Special Instructions --

Item Options

N/A N/A

Item Locations/Counts

ROOM NUMBER	ROOM NAME	COUNT
LOWER LEVEL		
113	STORAGE	1
COUNT TOTAL		1



Substitution Requests Accepted: Yes

Note: Image(s) may not depict exact product or finishes, see item options.



Sheet Name
Furniture Specifications
Project
FLINT PUBLIC LIBRARY RENOVATION
1026 E. Kearsley St.,
Flint, MI 48503

OPN Project No. **17215000**
Sheet Issue Date **4/28/2021**
Section Number **40.0**
Item Code **S-10**

Item Information

Section Number 40.0
Item Code S-11
Manufacturer U-line
Model Wide Span Storage Racks - Particle Board
Model Number H-2189
Dimensions 36"W. X 24"D. X 60"H.
Description Metal storage racks with particle board shelf tops. 3 shelves.
Special Instructions --

Item Options

N/A N/A

Item Locations/Counts

ROOM NUMBER	ROOM NAME	COUNT
LOWER LEVEL		
113	STORAGE	1
COUNT TOTAL		1



Substitution Requests Accepted: Yes

Note: Image(s) may not depict exact product or finishes, see item options.



Sheet Name
Furniture Specifications
Project
FLINT PUBLIC LIBRARY RENOVATION
1026 E. Kearsley St.,
Flint, MI 48503

OPN Project No. **17215000**
Sheet Issue Date **4/28/2021**
Section Number **40.0**
Item Code **S-11**

Item Information

Section Number 41.0
Item Code CH-3
Manufacturer Vitra
Model Hal Side Chair
Model Number HAL Wood
Dimensions --
Description Side chair with polypropelene seat and wood base.
Special Instructions --

Item Options

Seat Color 23 - Ice Grey
Wood Finish 45 - Black Pigmented Walnut

Item Locations/Counts

ROOM NUMBER	ROOM NAME	COUNT
MAIN LEVEL		
202	ADULT - FICTION	10
UPPER LEVEL		
302	ADULT - NON FICTION	6
305	CAFE	12
327	READING ROOM	3
COUNT TOTAL		31

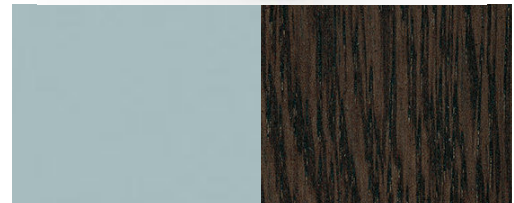

Substitution Requests Accepted: Yes

Note: Image(s) may not depict exact product or finishes, see item options.



Sheet Name
Furniture Specifications
Project
FLINT PUBLIC LIBRARY RENOVATION
1026 E. Kearsley St.,
Flint, MI 48503

OPN Project No. **17215000**
Sheet Issue Date **4/28/2021**
Section Number **41.0**
Item Code **CH-3**

Item Information

Section Number 41.0
Item Code O-16
Manufacturer Vitra
Model Eames Elephant
Model Number N/A
Dimensions --
Description Molded plastic elephant.
Special Instructions --

Item Options

Plastic Color 23.0 - Ice grey

Item Locations/Counts

ROOM NUMBER	ROOM NAME	COUNT
MAIN LEVEL		
212	CHILDREN'S COLLECTION	1
COUNT TOTAL		1



Substitution Requests Accepted: Yes

Note: Image(s) may not depict exact product or finishes, see item options.

Item Information

Section Number	41.0
Item Code	O-17
Manufacturer	Vitra
Model	Eames Elephant
Model Number	N/A
Dimensions	--
Description	Molded plastic elephant.
Special Instructions	--

Item Options

Plastic Color	03 - Poppy red
---------------	----------------

Item Locations/Counts

ROOM NUMBER	ROOM NAME	COUNT
MAIN LEVEL		
212	CHILDREN'S COLLECTION	2
COUNT TOTAL		2



Substitution Requests Accepted: Yes

Note: Image(s) may not depict exact product or finishes, see item options.

Item Information

Section Number 42.0
Item Code A-3
Manufacturer --
Model Seat Pads
Model Number --
Dimensions 30"W. X 24"D. X 1"H.
Description Seat Pads for learning stair - image is basis of design.
Special Instructions --

Item Options

Fabric Maharam - Scuba - Coral

Item Locations/Counts

ROOM NUMBER	ROOM NAME	COUNT
MAIN LEVEL		
209	YOUNG ADULT	8
210	LEARNING STAIR	4
COUNT TOTAL		12



Substitution Requests Accepted: Yes

Note: Image(s) may not depict exact product or finishes, see item options.



Sheet Name
Furniture Specifications
Project
FLINT PUBLIC LIBRARY RENOVATION
1026 E. Kearsley St.,
Flint, MI 48503

OPN Project No. **17215000**
Sheet Issue Date **4/28/2021**
Section Number **42.0**
Item Code **A-3**